

1 PANEL HEAD @ WALL  
SCALE: 6" = 1'-0"  
REF: D1

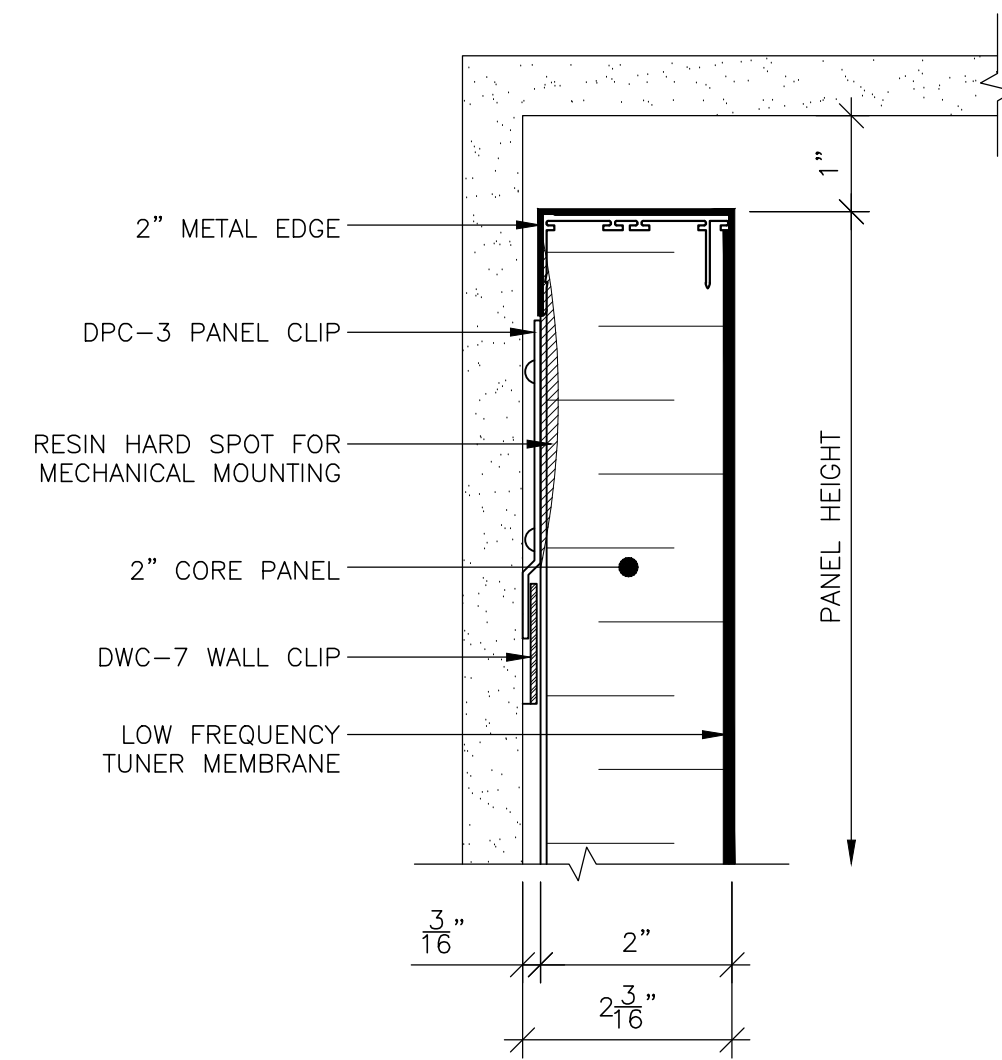

2 PANEL HEAD @ BULKHEAD  
SCALE: 6" = 1'-0"  
REF: D1

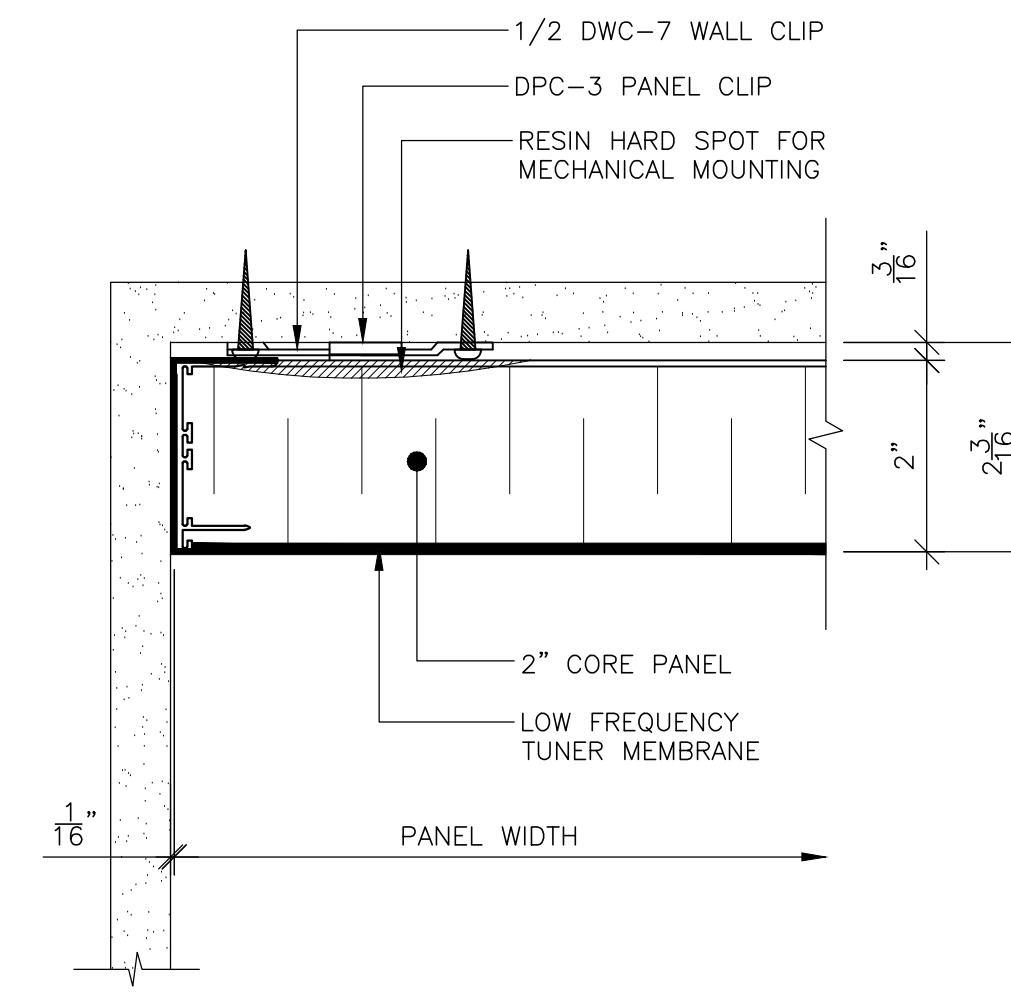

3 PANEL END @ WALL  
SCALE: 6" = 1'-0"  
REF: D1

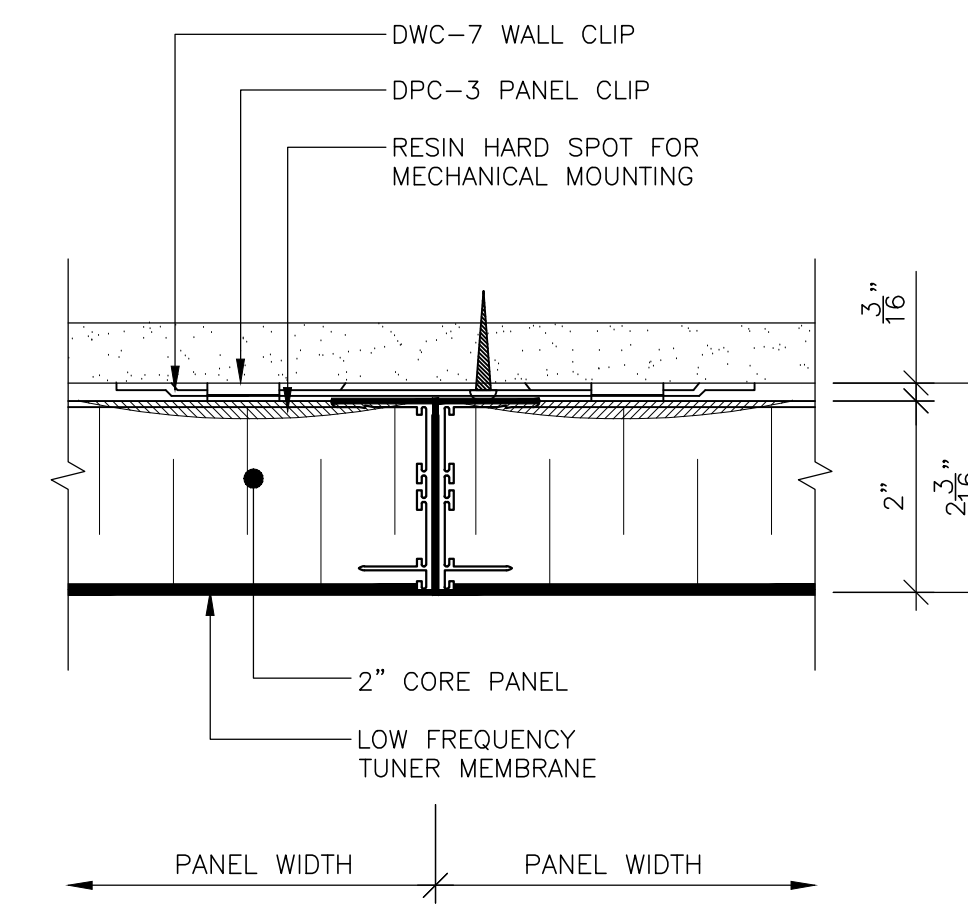

4 VERT. BUTT JOINT DET.  
SCALE: 6" = 1'-0"  
REF: D1

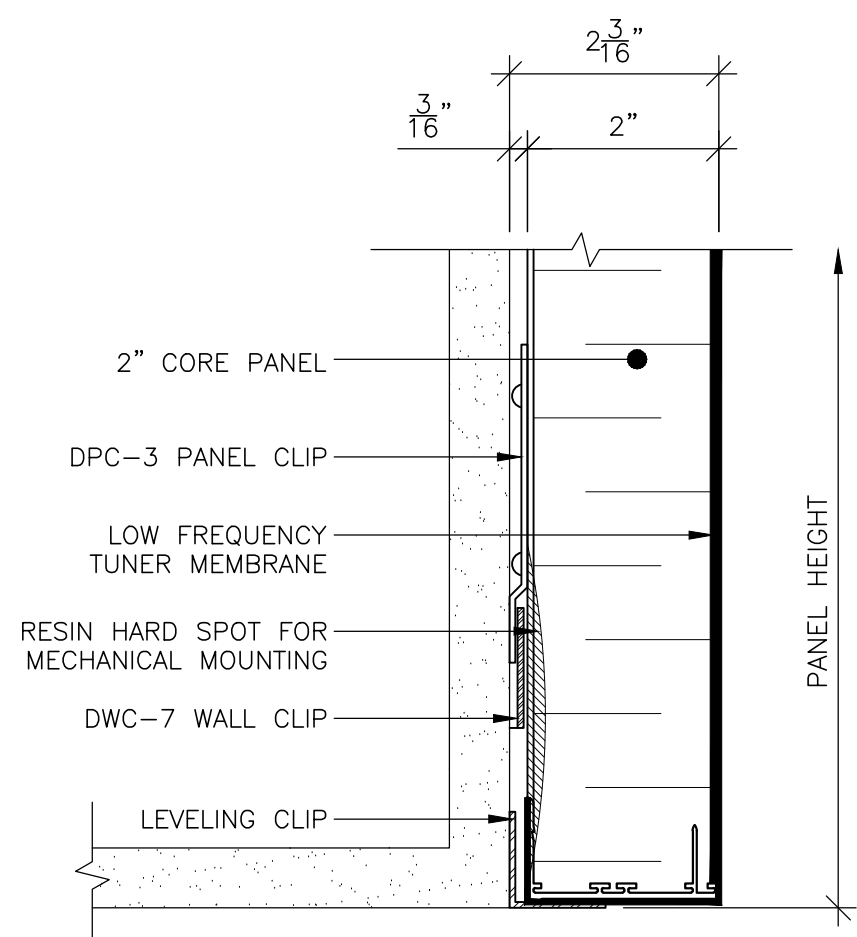

5 PANEL BASE @ BULKHEAD  
SCALE: 6" = 1'-0"  
REF: D1

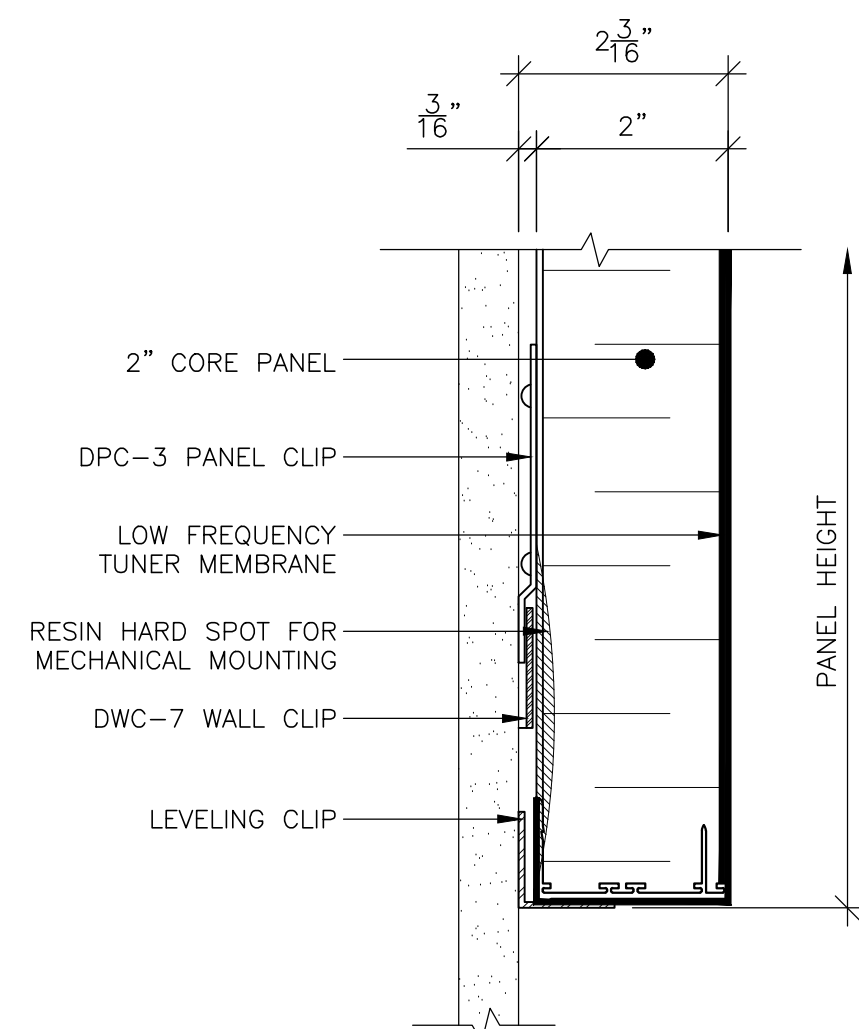

6 PANEL BASE @ WALL  
SCALE: 6" = 1'-0"  
REF: D1

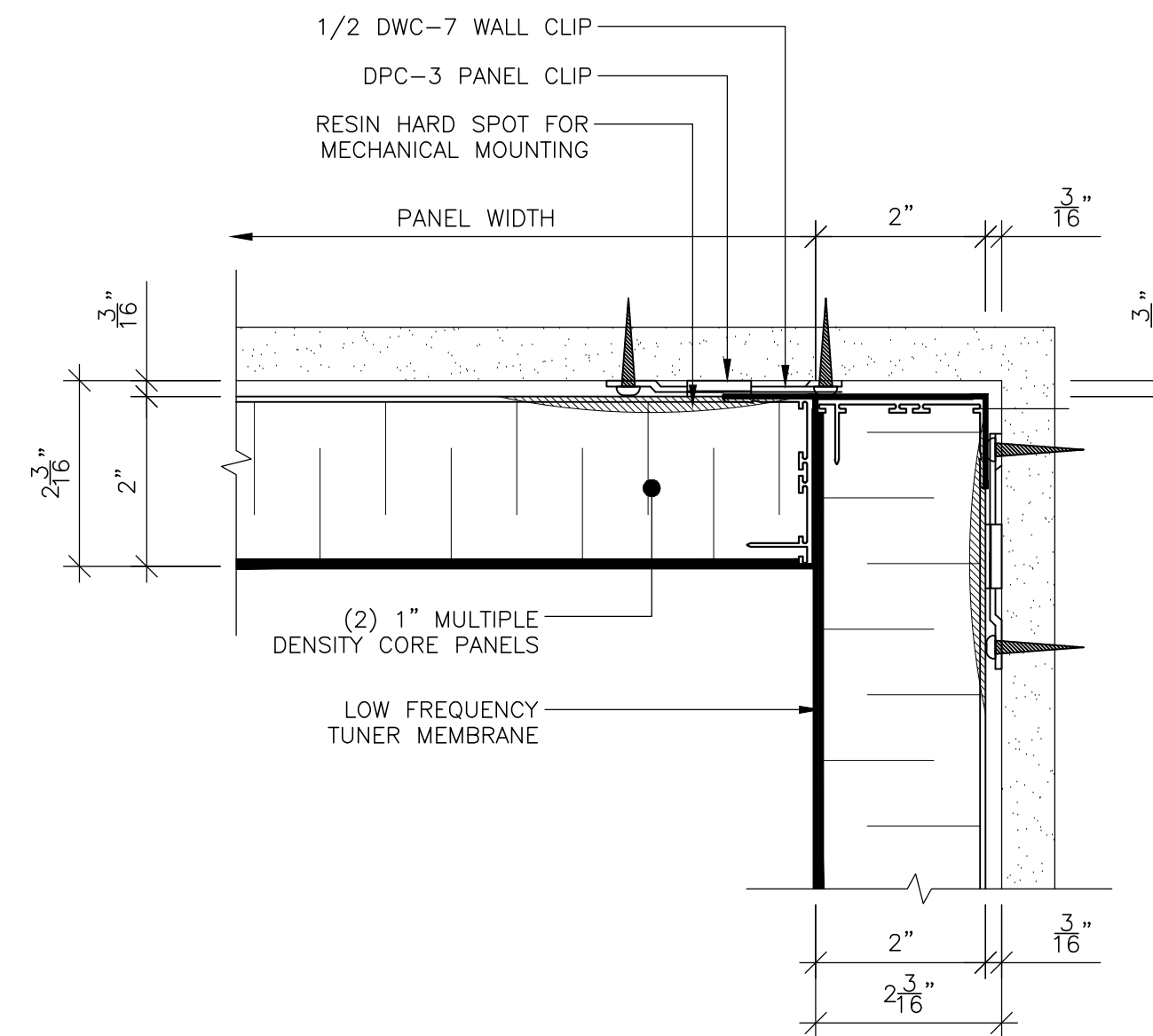

7 PANEL END @ CORNER  
SCALE: 6" = 1'-0"  
REF: D1

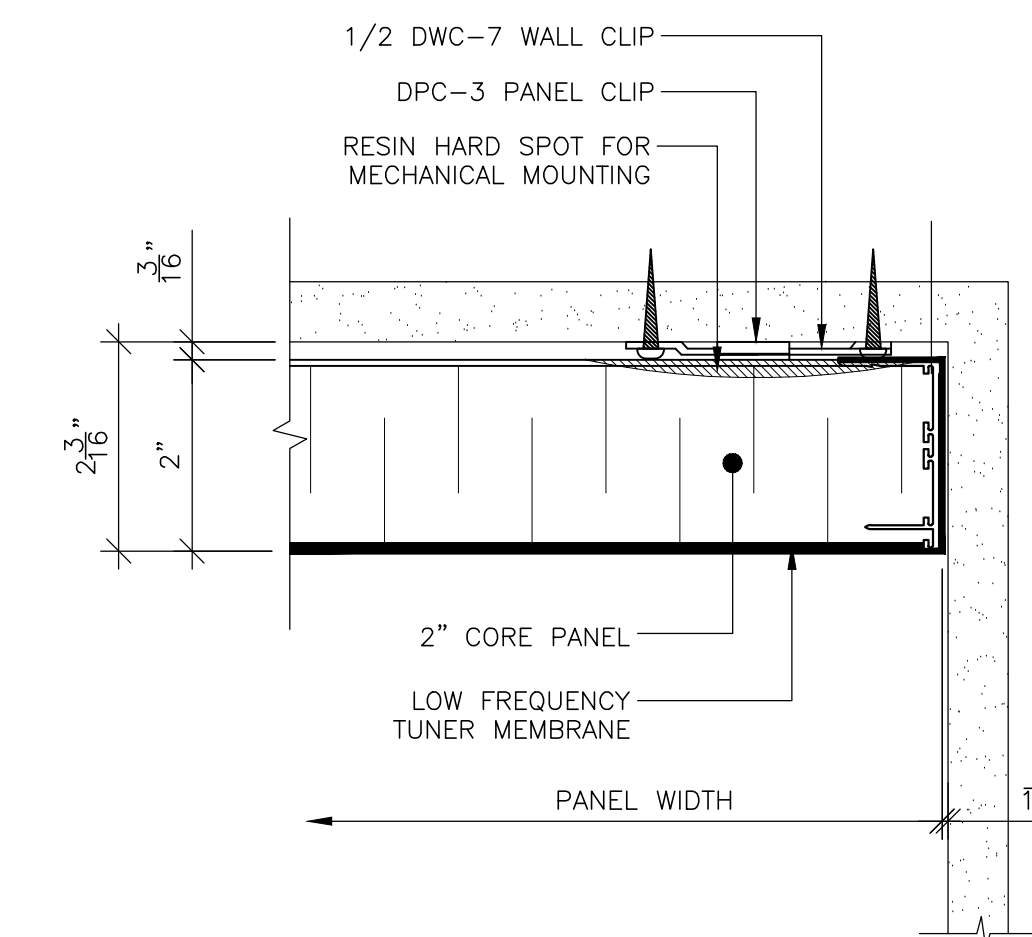

8 PANEL END @ WALL  
SCALE: 6" = 1'-0"  
REF: D1

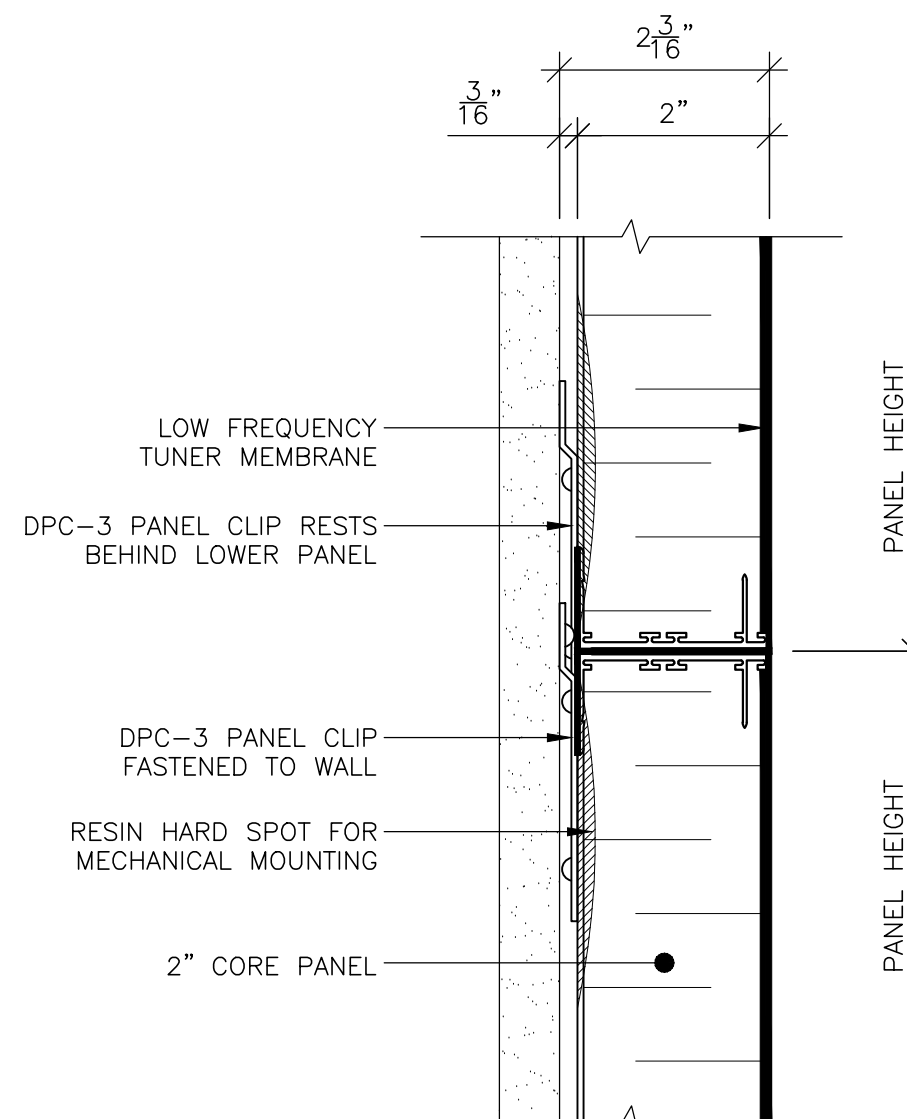

9 HORIZ. BUTT JOINT DET.  
SCALE: 6" = 1'-0"  
REF: D1

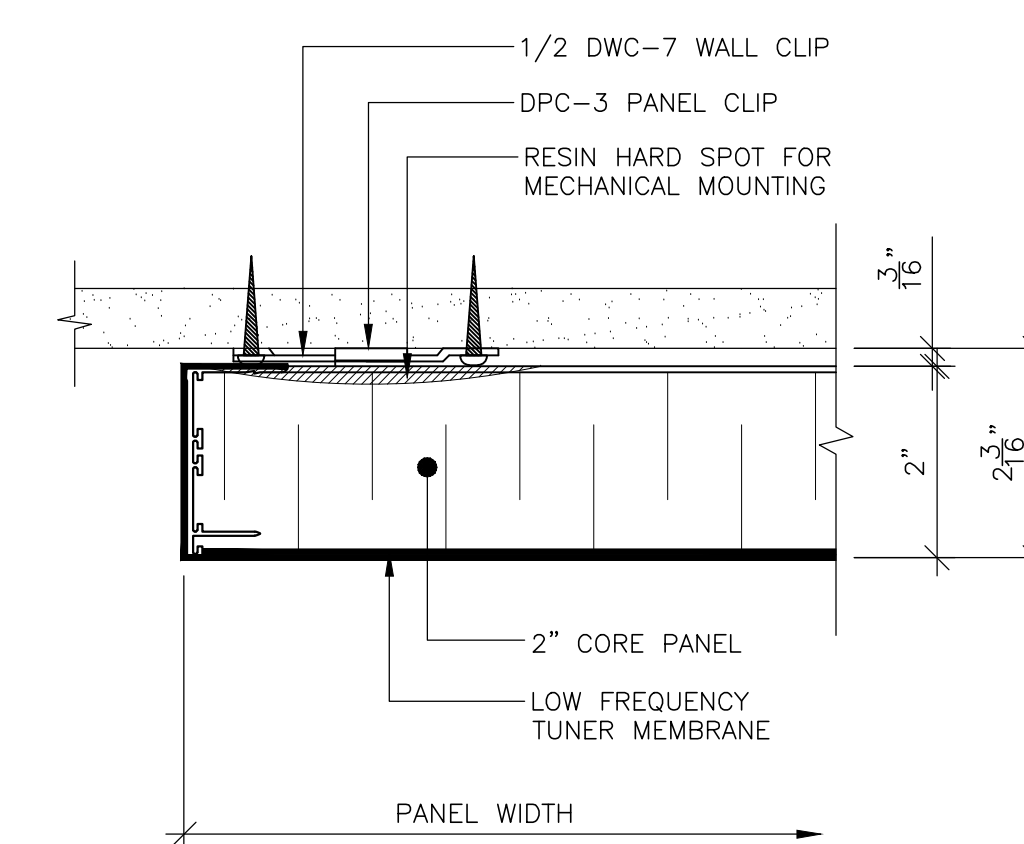

10 PANEL END @ WALL  
SCALE: 6" = 1'-0"  
REF: D1

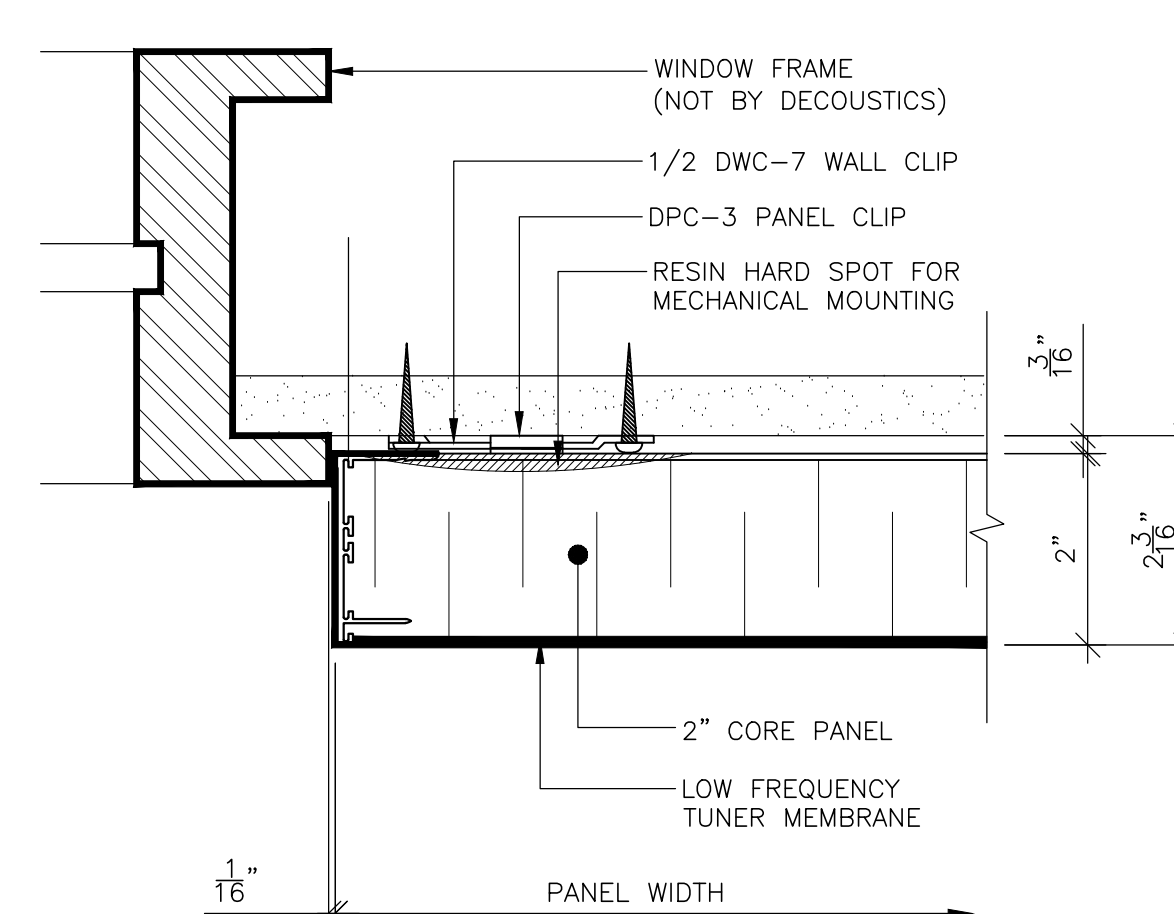

11 PANEL END @ FRAME  
SCALE: 6" = 1'-0"  
REF: D1

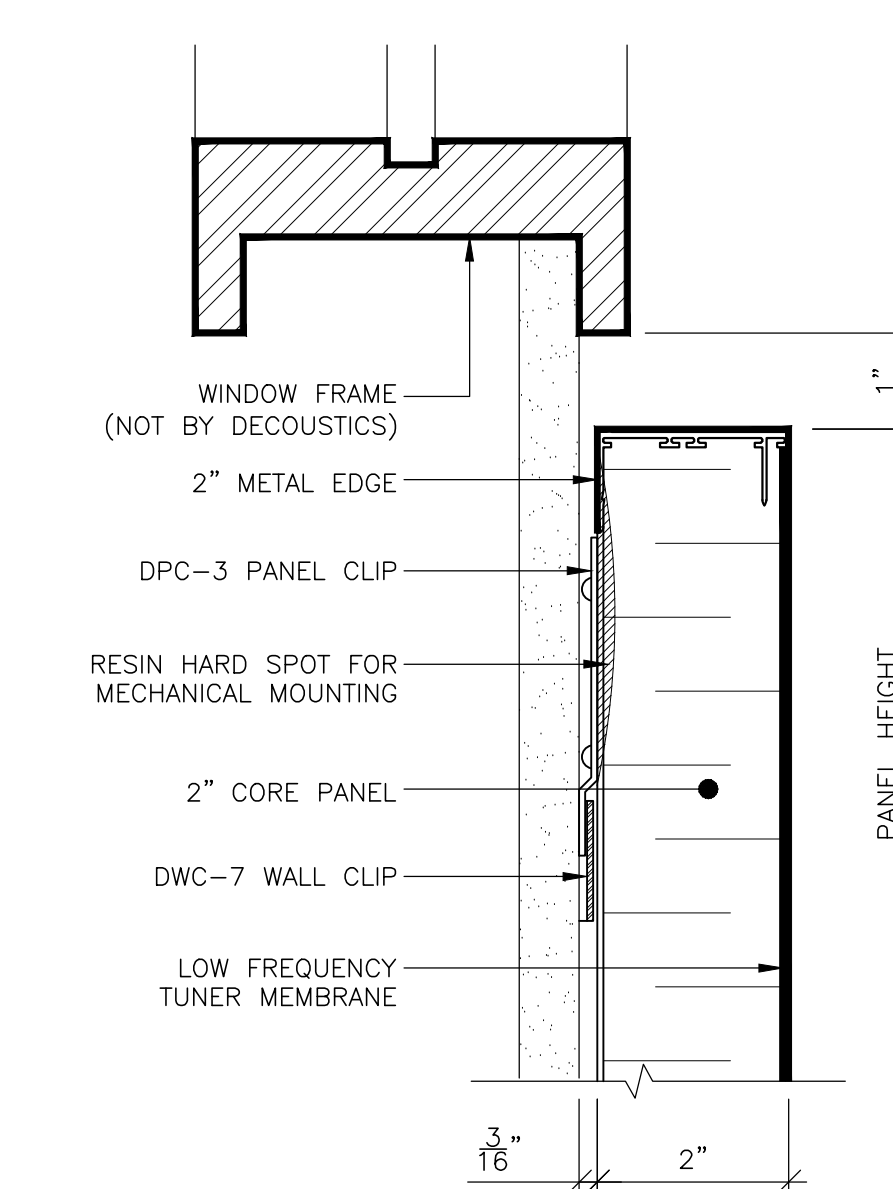

12 PANEL HEAD @ FRAME  
SCALE: 6" = 1'-0"  
REF: D1

GENERAL NOTES:

- (\*) PLEASE SUPPLY FIELD DIMENSIONS TO THE NEAREST 1/16". DECOUSTICS WILL CALCULATE PANEL SIZES.
- PLEASE VERIFY AND CONFIRM ALL DIMENSIONS, MOUNTING METHODS, AND DETAILS.
- ALL PANEL PENETRATIONS FOR LIGHT FIXTURES, ELECTRICAL OUTLETS, ETC. TO BE FIELD CUT BY OTHERS. (NOT BY DECOUSTICS)
- ALL GRILLES, FIXTURES, LIGHTS ETC. TO BE SUPPORTED INDEPENDENTLY OF WALL PANELS.
- THE FINISHES USED ON DECOUSTICS PANELS ARE DIRECTIONAL. THE BACK OF EACH PANEL WILL BE MARKED TO SHOW THE CORRECT ORIENTATION FOR INSTALLATION.
- FOR ADDITIONAL PANEL INSTALLATION DETAILS, SEE DATA SHEETS.

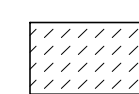
PANEL  
  
 PANEL TYPE: L.F.T. 2" THICK FLAT WALL PANELS  
 MOUNTING: MECHANICAL MOUNT  
 EDGE DETAIL: SQUARE RESIN EDGE  
 FABRIC FINISH: TBD  
 COLOR: TBD

FABRIC - L.F.T

REV.	PURPOSE	DATE
0	REVISION	30 APRIL 2020

THIS DRAWING IS THE SOLE PROPERTY OF DECOUSTICS LIMITED AND CONTAINS CONFIDENTIAL INFORMATION AND IS TO BE USED ONLY UNDER EXPRESS AUTHORITY GIVEN, IN WRITING, BY DECOUSTICS LIMITED.

**decoustics**  
 SAINT-GOBAIN  
 61 Royal Group Crescent, Woodbridge  
 Ontario L4H 1X9 Canada  
 Toll Free: 800-387-3889  
 Main: 905-652-5200  
 Fax: 905-652-2505

DRAWING	DRAWING TITLE	DRAWN BY	DWG. NO.
ARCHITECT	ARCHITECT	JL	D1
		CHECKED BY	PROJECT #
		SP	#####
			1 OF X

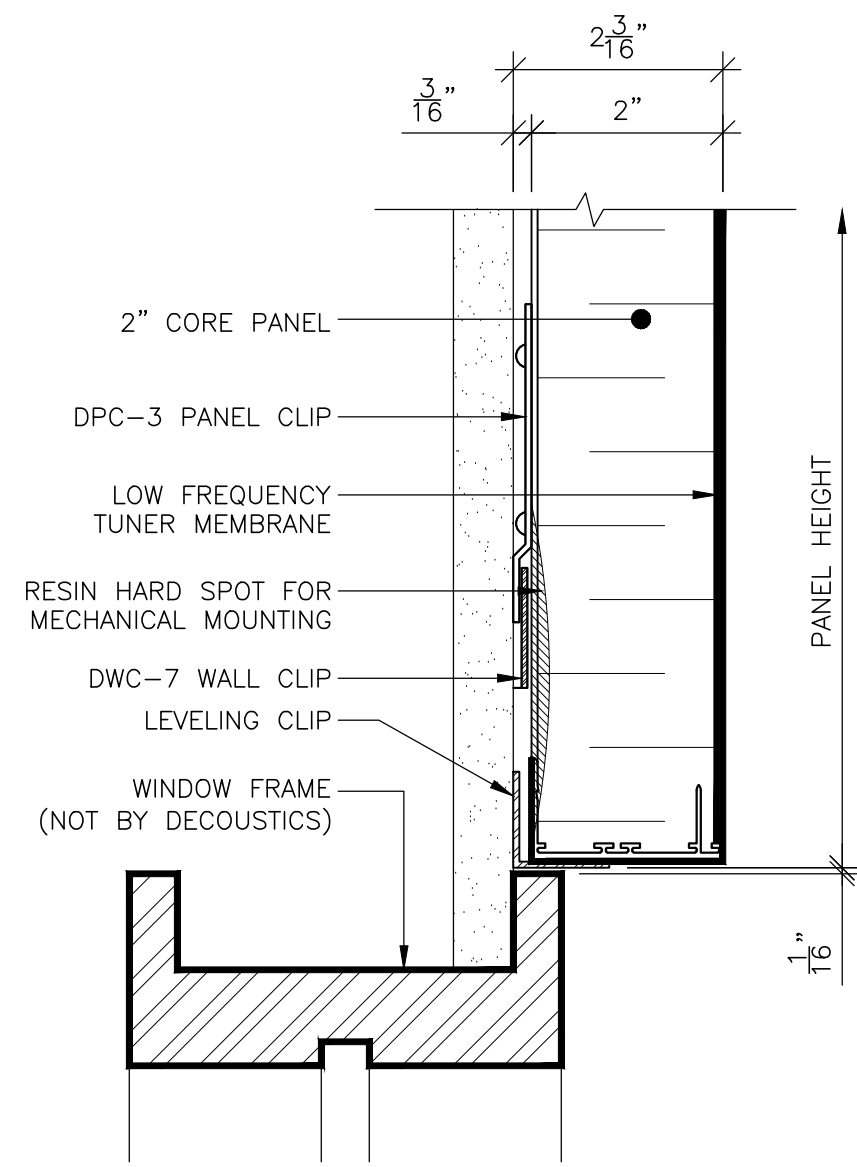

1 PANEL BASE @ FRAME  
 D2 SCALE: 6" = 1'-0"  
 REF:

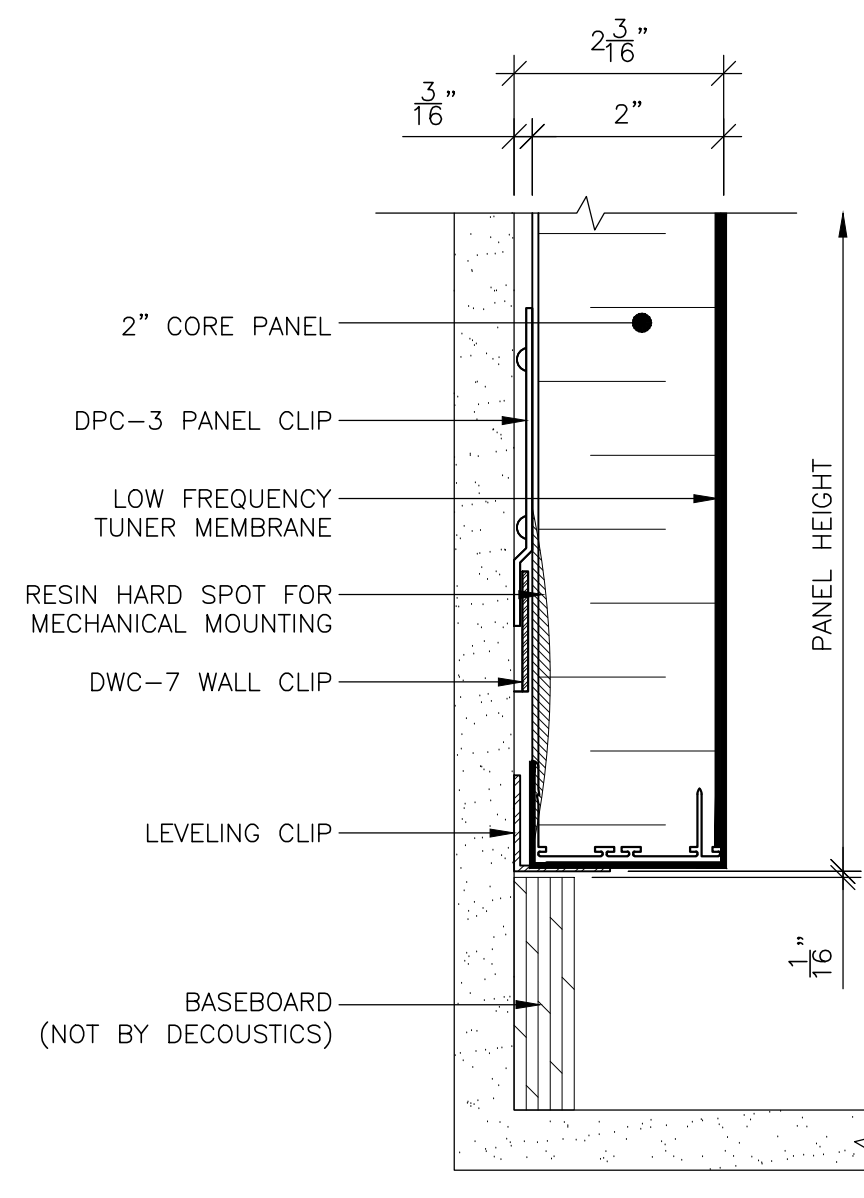

2 PANEL BASE @ BASEBOARD  
 D2 SCALE: 6" = 1'-0"  
 REF:

GENERAL NOTES:

- (\*) PLEASE SUPPLY FIELD DIMENSIONS TO THE NEAREST 1/16". DECOUSTICS WILL CALCULATE PANEL SIZES.
- PLEASE VERIFY AND CONFIRM ALL DIMENSIONS, MOUNTING METHODS, AND DETAILS.
- ALL PANEL PENETRATIONS FOR LIGHT FIXTURES, ELECTRICAL OUTLETS, ETC. TO BE FIELD CUT BY OTHERS. (NOT BY DECOUSTICS)
- ALL GRILLES, FIXTURES, LIGHTS ETC. TO BE SUPPORTED INDEPENDENTLY OF WALL PANELS.
- THE FINISHES USED ON DECOUSTICS PANELS ARE DIRECTIONAL. THE BACK OF EACH PANEL WILL BE MARKED TO SHOW THE CORRECT ORIENTATION FOR INSTALLATION.
- FOR ADDITIONAL PANEL INSTALLATION DETAILS, SEE DATA SHEETS.

PANEL

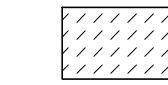

PANEL TYPE : L.F.T, 2" THICK FLAT WALL PANELS  
 MOUNTING: MECHANICAL MOUNT  
 EDGE DETAIL: SQUARE RESIN EDGE  
 FABRIC FINISH: TBD  
 COLOR: TBD

FABRIC - L.F.T

REV.	PURPOSE	DATE
0	ORIGINAL ISSUE	30 APRIL 2020

THIS DRAWING IS THE SOLE PROPERTY OF DECOUSTICS LIMITED AND CONTAINS CONFIDENTIAL INFORMATION AND IS TO BE USED ONLY UNDER EXPRESS AUTHORITY GIVEN, IN WRITING, BY DECOUSTICS LIMITED.

**decoustics**  
 SAINT-GOBAIN

61 Royal Group Crescent, Woodbridge  
 Ontario L4H 1X9 Canada  
 Toll Free: 800-387-3889  
 Main: 905-652-5200  
 Fax: 905-652-2505

DRAWING	DRAWING TITLE	DRAWN BY	DWG. NO.
ARCHITECT	ARCHITECT	JL	D2
		CHECKED BY	PROJECT #
		SP	#####
			2 OF X