

GENERAL NOTES:

- (*) PLEASE SUPPLY FIELD DIMENSIONS TO THE NEAREST 1/6". DECOUSTICS WILL CALCULATE PANEL SIZES.
- PLEASE VERIFY AND CONFIRM ALL DIMENSIONS, MOUNTING METHODS, AND DETAILS.
- ALL PANEL PENETRATIONS FOR LIGHT FIXTURES, ELECTRICAL OUTLETS, ETC. TO BE FIELD CUT BY OTHERS. (NOT BY DECOUSTICS)
- ALL GRILLES, FIXTURES, LIGHTS ETC. TO BE SUPPORTED INDEPENDENTLY OF WALL PANELS.
- THE FINISHES USED ON DECOUSTICS PANELS ARE DIRECTIONAL. THE BACK OF EACH PANEL WILL BE MARKED TO SHOW THE CORRECT ORIENTATION FOR INSTALLATION.
- FOR ADDITIONAL PANEL INSTALLATION DETAILS, SEE DATA SHEETS.

PANEL

 PANEL TYPE : HIR 4, 1" THICK FLAT WALL PANELS
 MOUNTING : MECHANICAL MOUNT
 EDGE DETAIL : SQUARE RESIN EDGE
 FABRIC FINISH : TBD
 COLOR : TBD

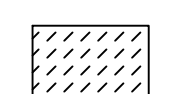
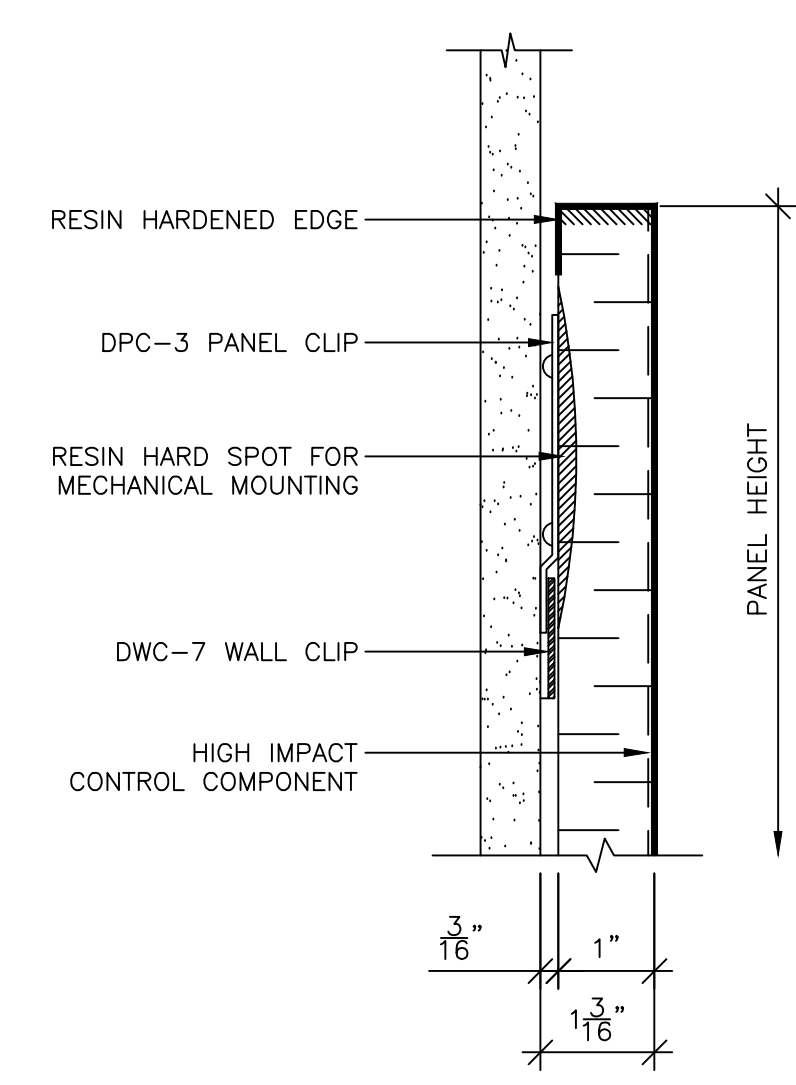

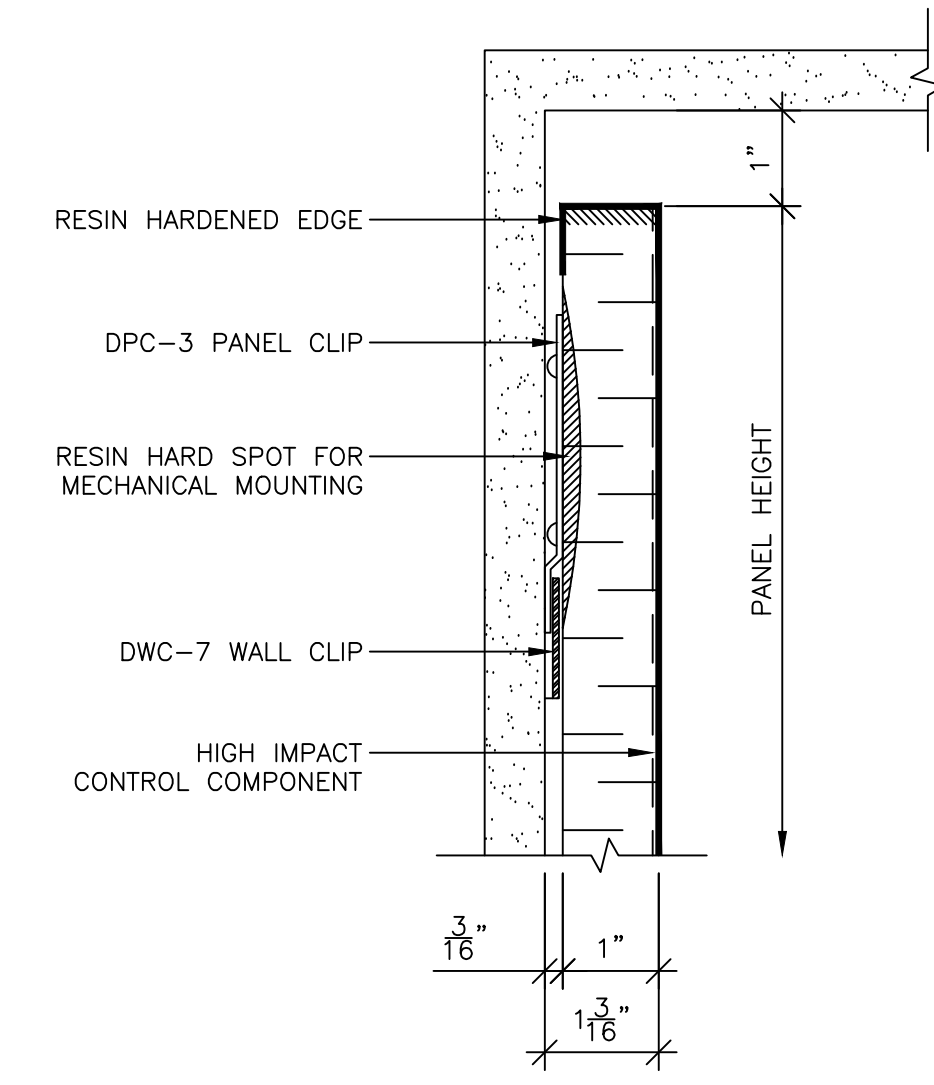
1 PANEL HEAD @ WALL
 SCALE: 6" = 1'-0"
 REF:

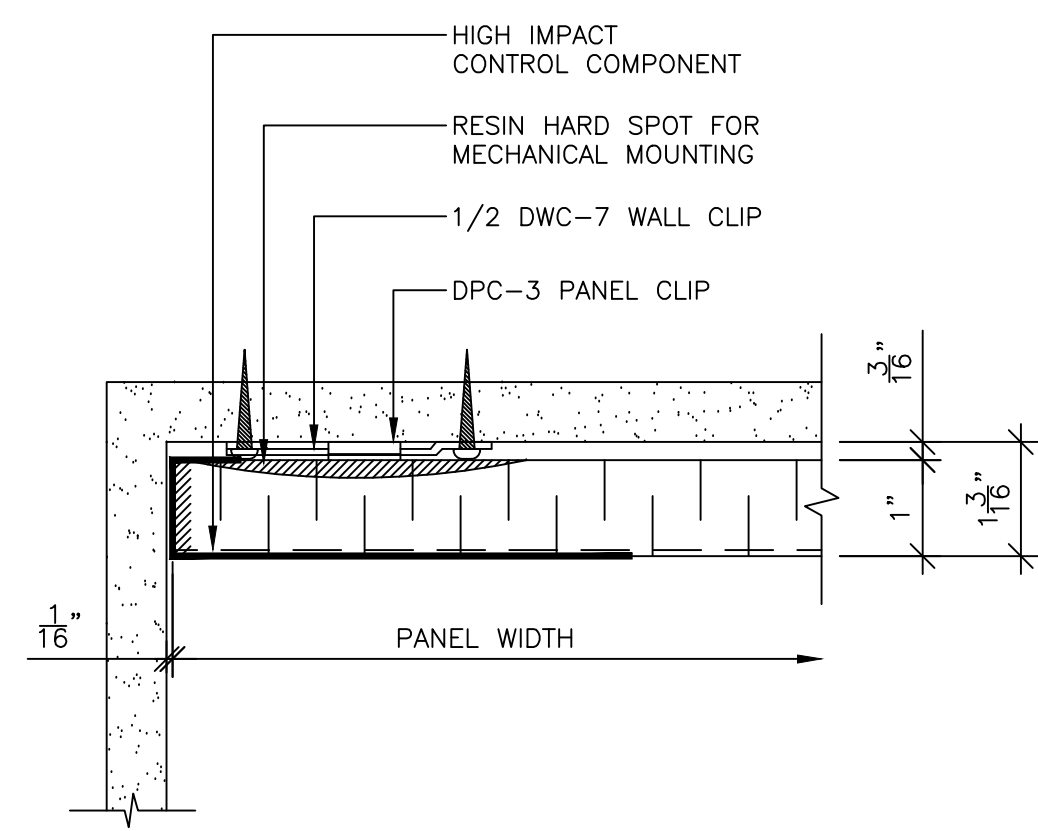

2 PANEL HEAD @ BULKHEAD
 SCALE: 6" = 1'-0"
 REF:



3 PANEL END @ WALL
 SCALE: 6" = 1'-0"
 REF:

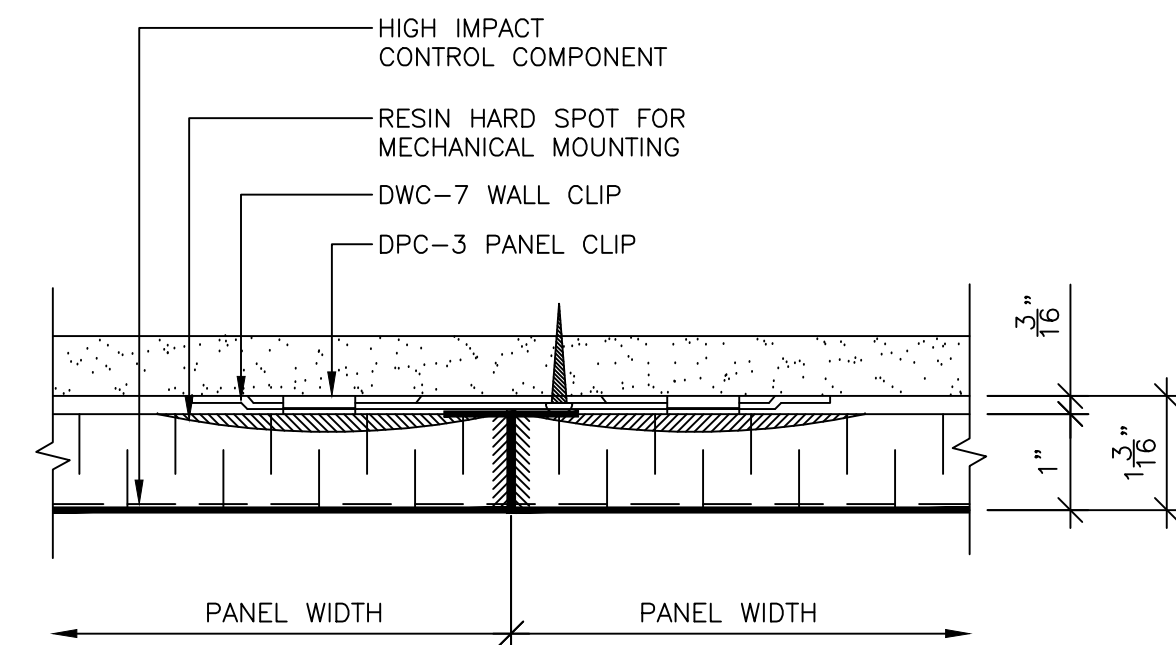

4 VERT. BUTT JOINT DET.
 SCALE: 6" = 1'-0"
 REF:

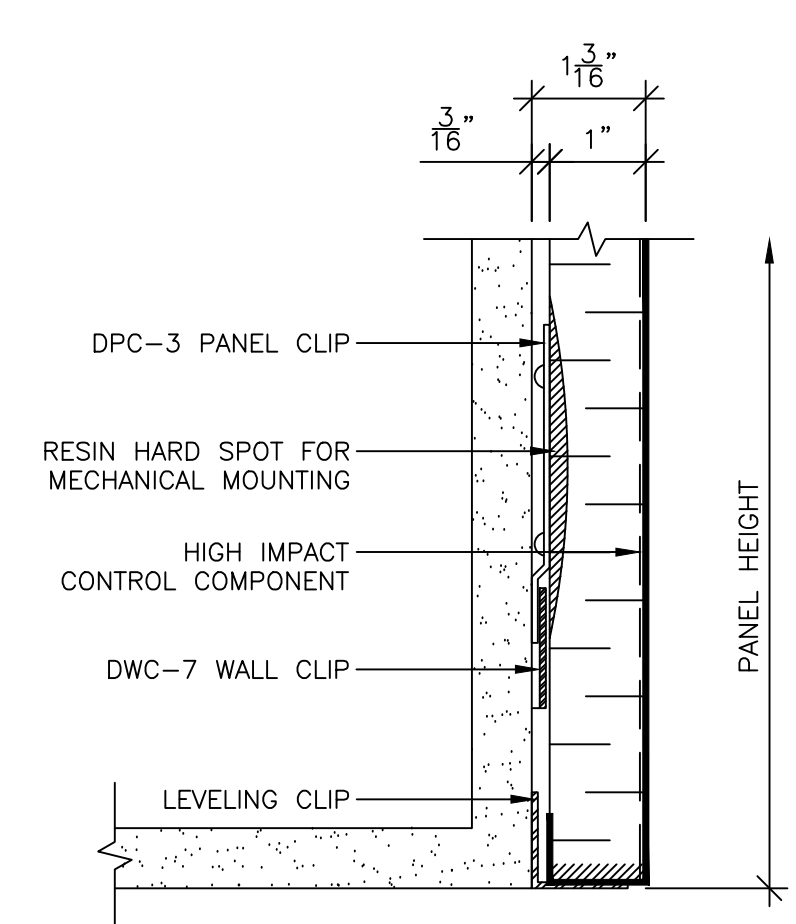

5 PANEL BASE @ BULKHEAD
 SCALE: 6" = 1'-0"
 REF:

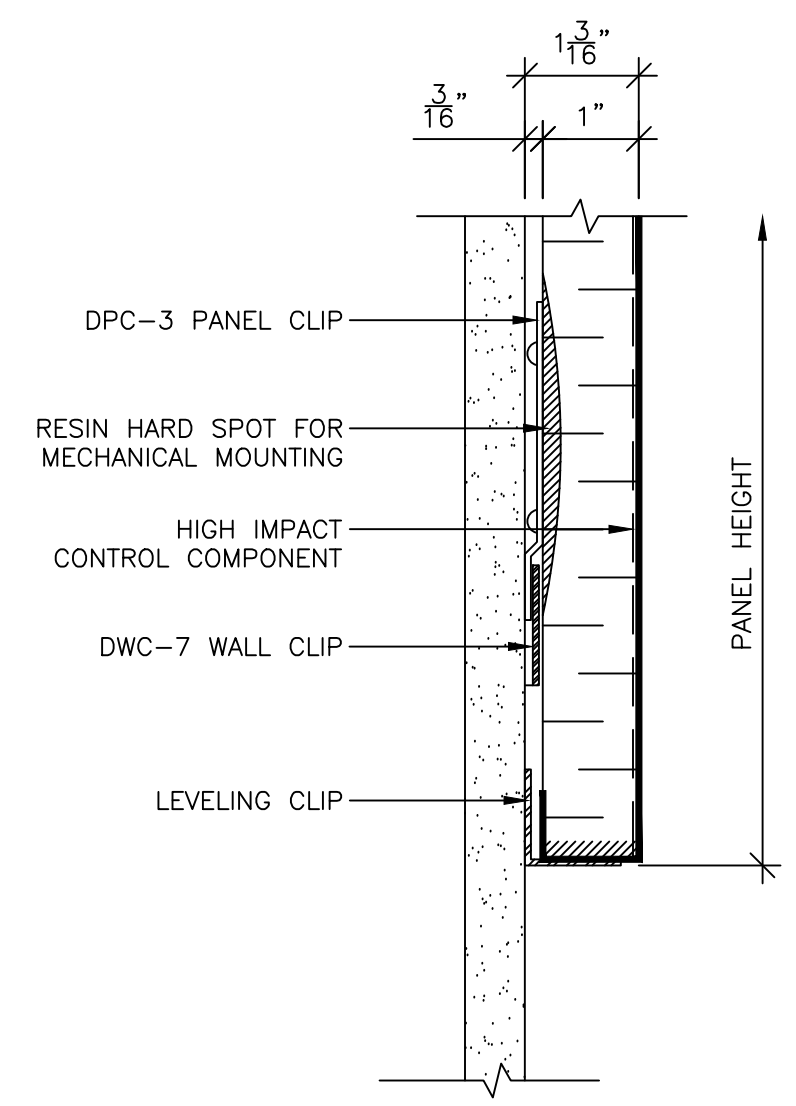

6 PANEL BASE @ WALL
 SCALE: 6" = 1'-0"
 REF:

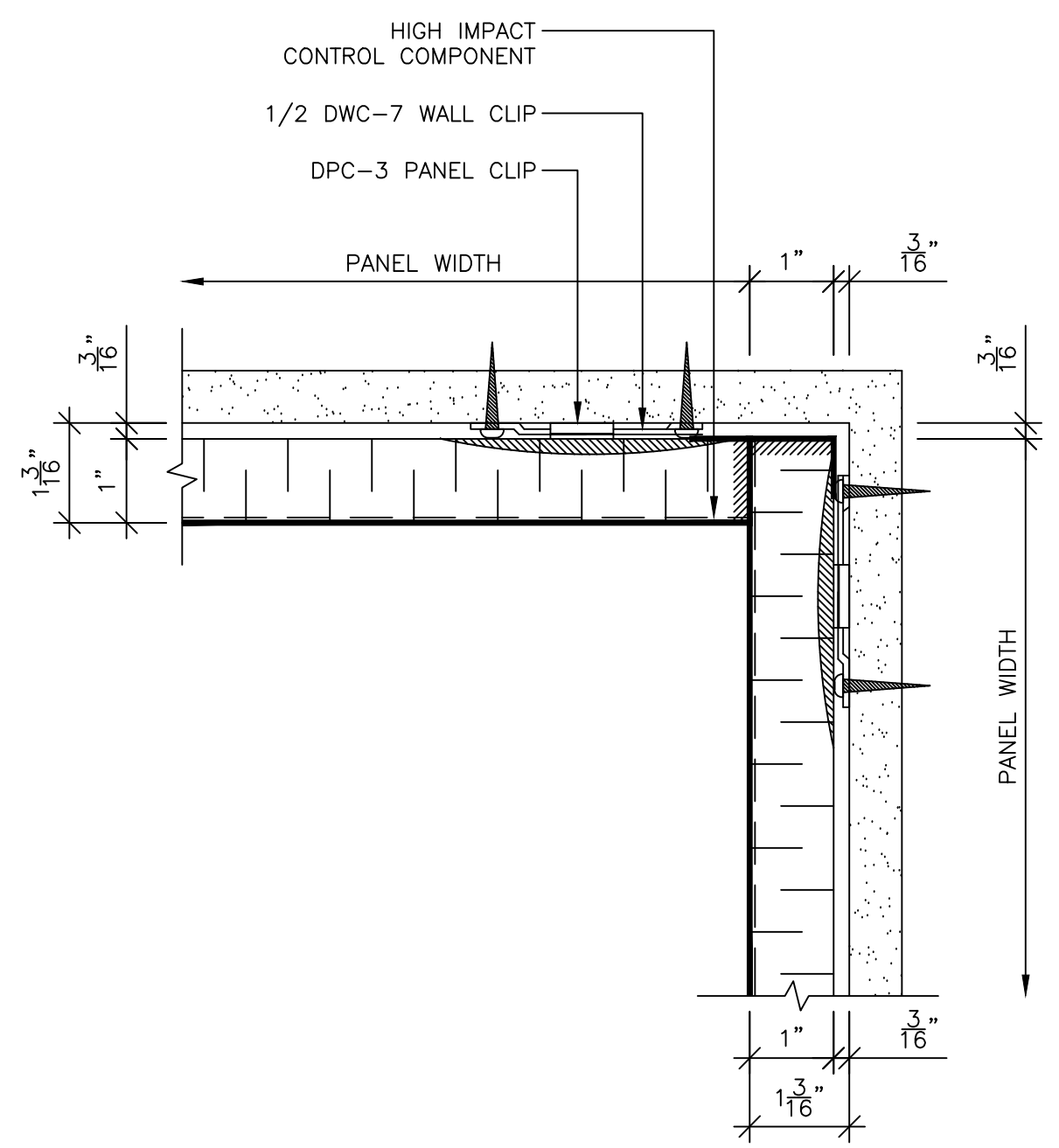

7 PANEL END @ CORNER
 SCALE: 6" = 1'-0"
 REF:

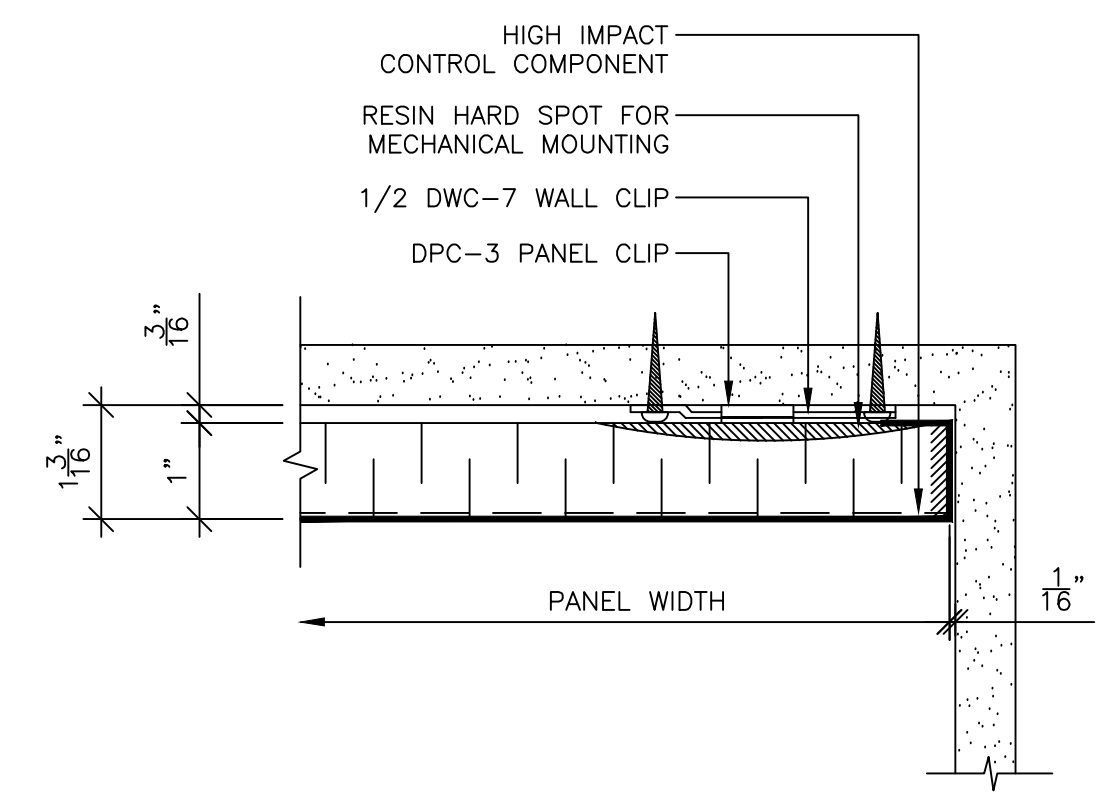

8 PANEL END @ WALL
 SCALE: 6" = 1'-0"
 REF:

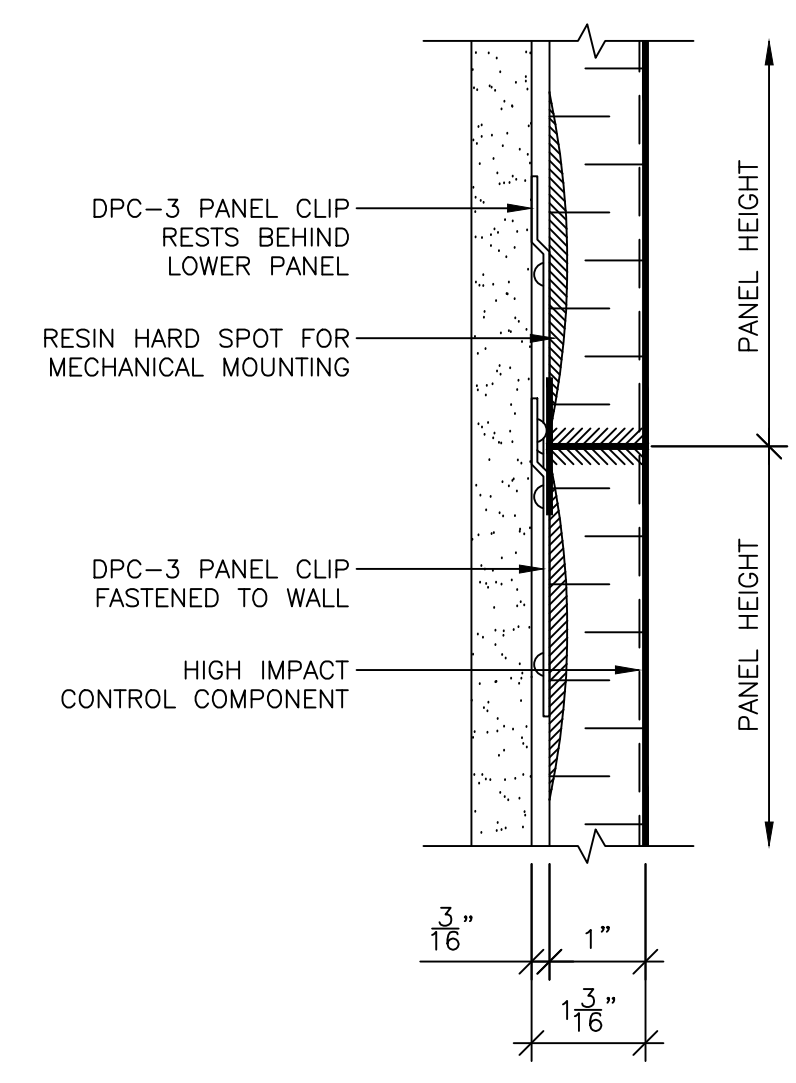

9 HORIZ. BUTT JOINT DET.
 SCALE: 6" = 1'-0"
 REF:

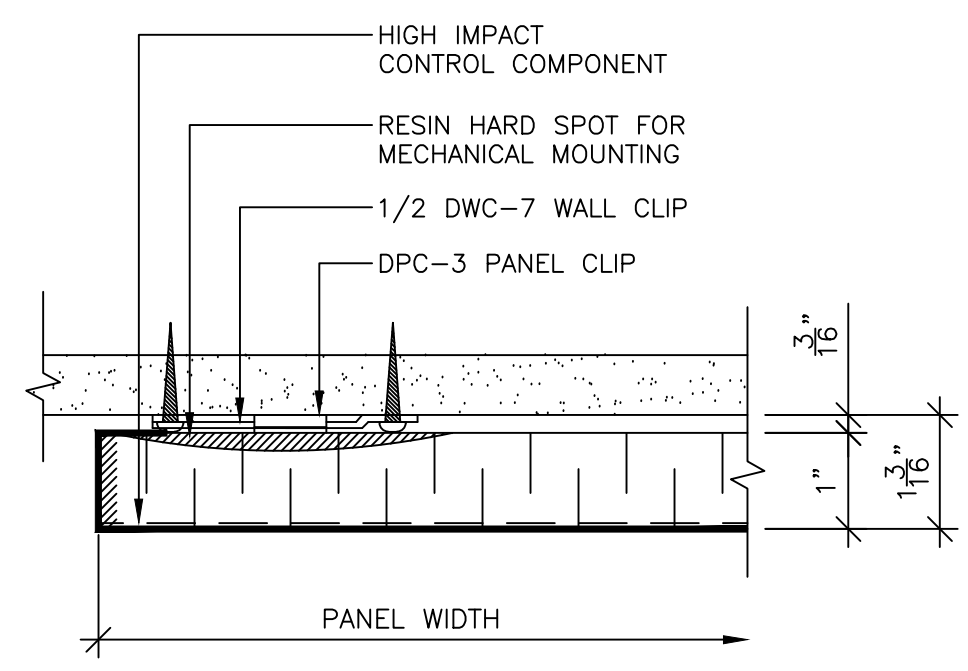

10 PANEL END @ WALL
 SCALE: 6" = 1'-0"
 REF:

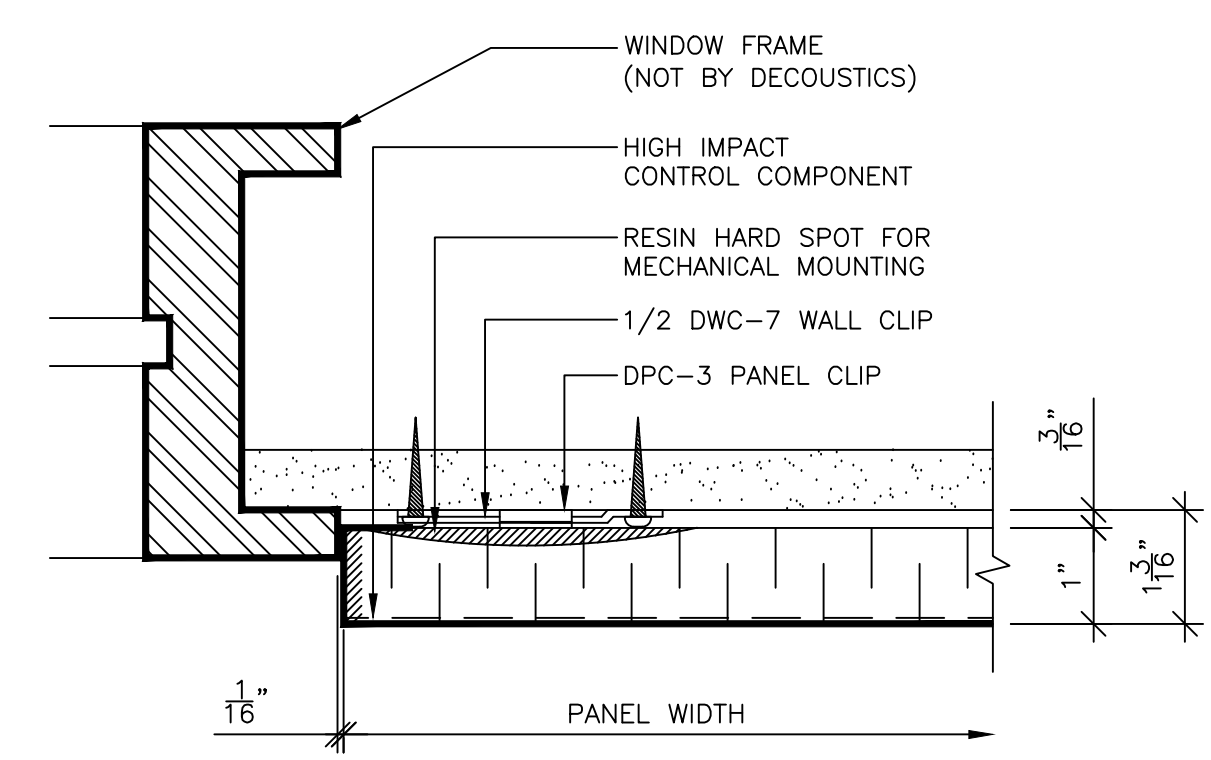

11 PANEL END @ FRAME
 SCALE: 6" = 1'-0"
 REF:

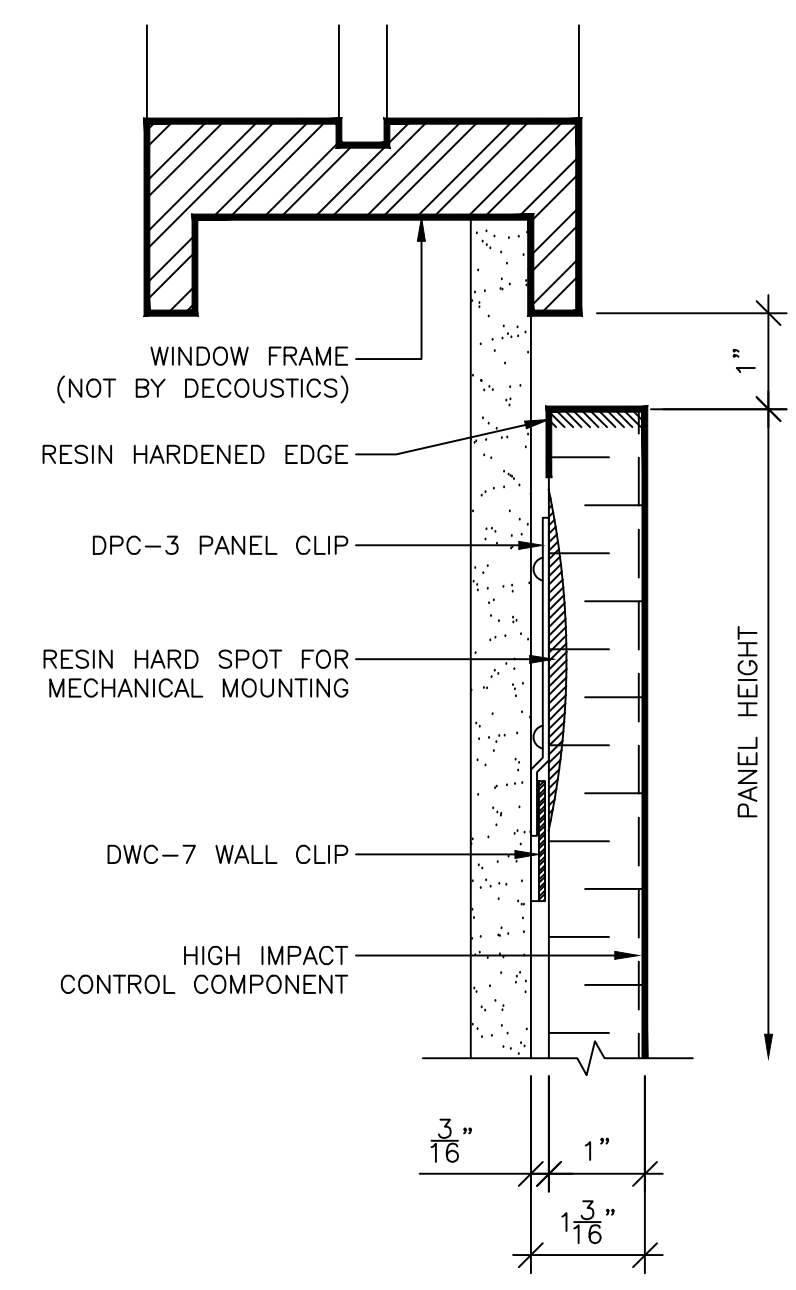

12 PANEL HEAD @ FRAME
 SCALE: 6" = 1'-0"
 REF:

FABRIC - HIR 4

REV.	PURPOSE	DATE
0	REVISION	30 APRIL 2020

THIS DRAWING IS THE SOLE PROPERTY OF DECOUSTICS LIMITED AND IS TO BE USED ONLY UNDER EXPRESS AUTHORITY GIVEN, IN WRITING, BY DECOUSTICS LIMITED.

decoustics
 SAINT-GOBAIN

61 Royal Group Crescent, Woodbridge
 Ontario L4H 1X9 Canada
 Toll Free: 800-387-3899
 Main: 905-652-5200
 Fax: 905-652-2505

DRAWING	DRAWN BY	DWG. NO.
	JL	
	CHECKED BY	
	SP	
ARCHITECT	PROJECT #	
ARCHITECT	#####	

D1
 1 OF X

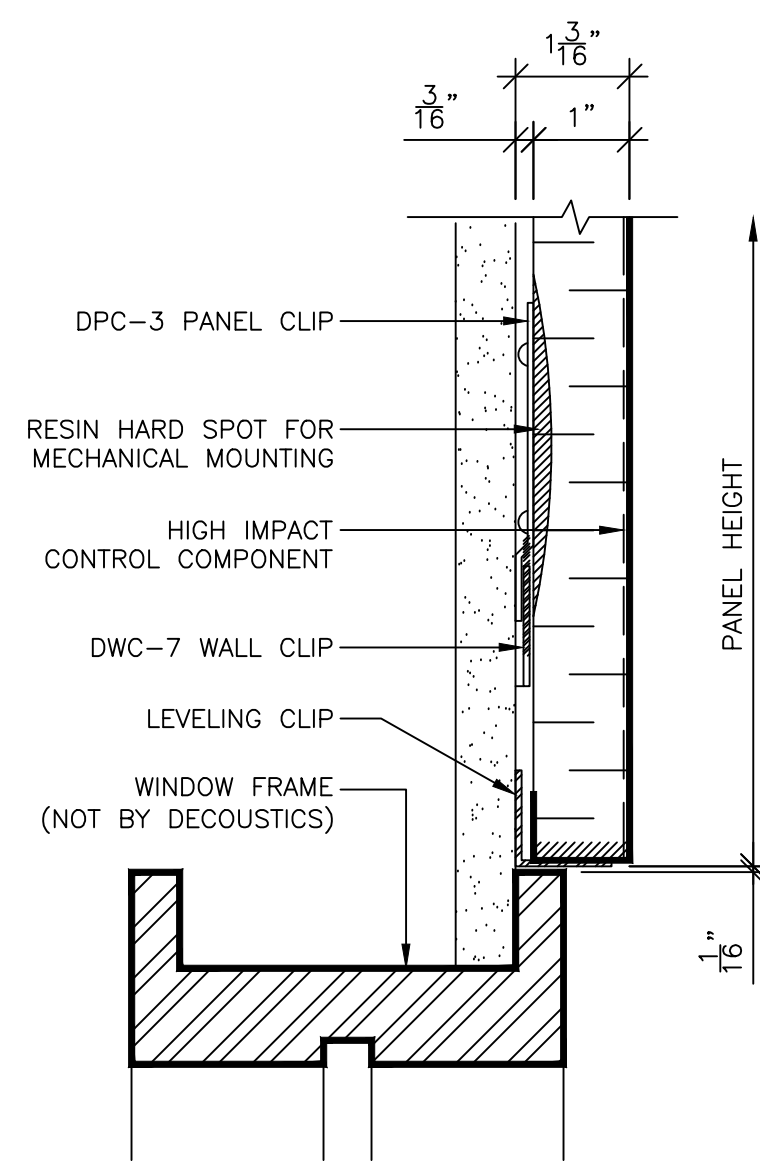

1 PANEL BASE @ FRAME
SCALE: 6" = 1'-0"
REF:

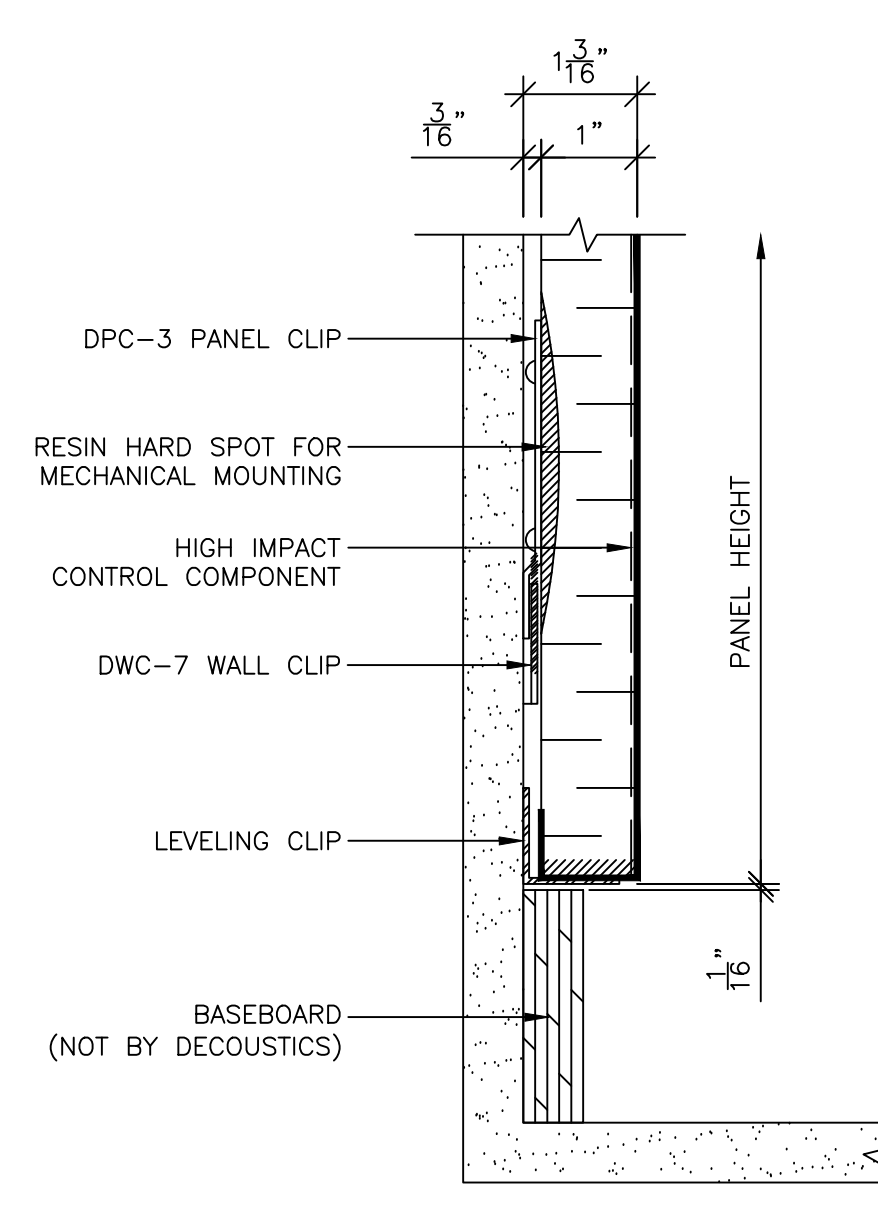

2 PANEL BASE @ BASEBOARD
SCALE: 6" = 1'-0"
REF:

GENERAL NOTES:

- (*) PLEASE SUPPLY FIELD DIMENSIONS TO THE NEAREST 1/8". DECOUSTICS WILL CALCULATE PANEL SIZES.
- PLEASE VERIFY AND CONFIRM ALL DIMENSIONS, MOUNTING METHODS, AND DETAILS.
- ALL PANEL PENETRATIONS FOR LIGHT FIXTURES, ELECTRICAL OUTLETS, ETC. TO BE FIELD CUT BY OTHERS. (NOT BY DECOUSTICS)
- ALL GRILLES, FIXTURES, LIGHTS ETC. TO BE SUPPORTED INDEPENDENTLY OF WALL PANELS.
- THE FINISHES USED ON DECOUSTICS PANELS ARE DIRECTIONAL. THE BACK OF EACH PANEL WILL BE MARKED TO SHOW THE CORRECT ORIENTATION FOR INSTALLATION.
- FOR ADDITIONAL PANEL INSTALLATION DETAILS, SEE DATA SHEETS.

PANEL

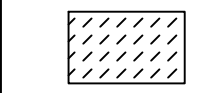

PANEL TYPE : HIR 4, 1" THICK FLAT WALL PANELS
MOUNTING: MECHANICAL MOUNT
EDGE DETAIL: SQUARE RESIN EDGE
FABRIC FINISH: TBD
COLOR: TBD

FABRIC - HIR 4

REV.	PURPOSE	DATE
0	REVISION	30 APRIL 2020

THIS DRAWING IS THE SOLE PROPERTY OF DECOUSTICS LIMITED AND CONTAINS CONFIDENTIAL INFORMATION AND IS TO BE USED ONLY UNDER EXPRESS AUTHORITY GIVEN, IN WRITING, BY DECOUSTICS LIMITED.

decoustics
SAINT-GOBAIN

61 Royal Group Crescent, Woodbridge
Ontario L4H 1X9 Canada
Toll Free: 800-387-3809
Main: 905-652-5200
Fax: 905-652-2505

DRAWING	DRAWING TITLE	DRAWN BY	DWG. NO.
ARCHITECT	ARCHITECT	JL	D2
		CHECKED BY	PROJECT #
		SP	#####
			2 OF X