

1 PERIMETER PANEL DETAIL
D1 SCALE: 6" = 1'-0"

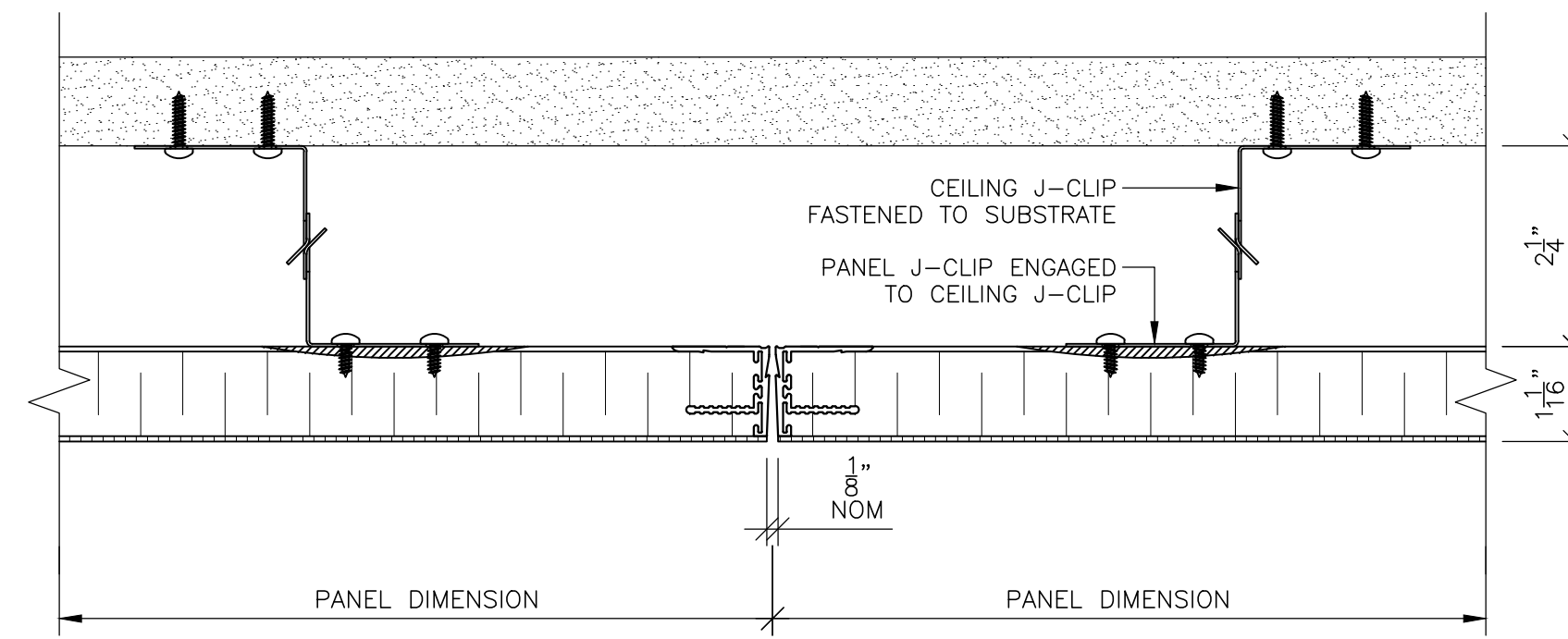

2 PANEL JOINT DETAIL
D1 SCALE: 6" = 1'-0"

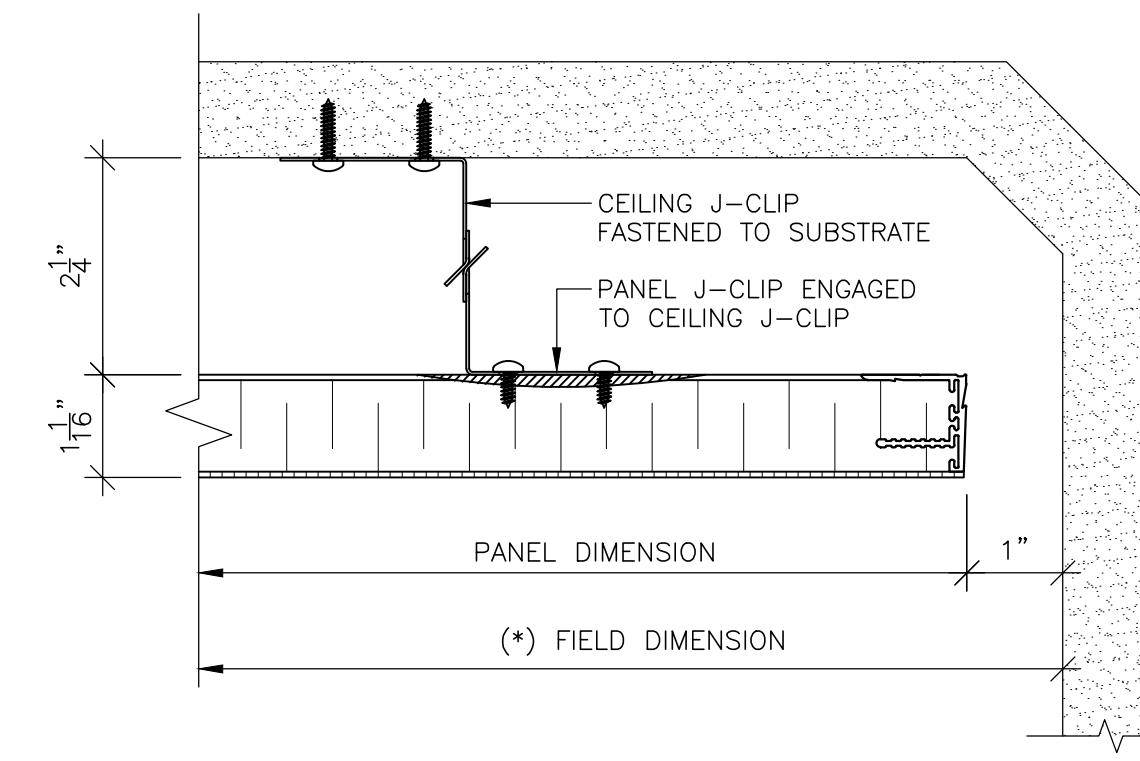

3 PERIMETER PANEL DETAIL
D1 SCALE: 6" = 1'-0"

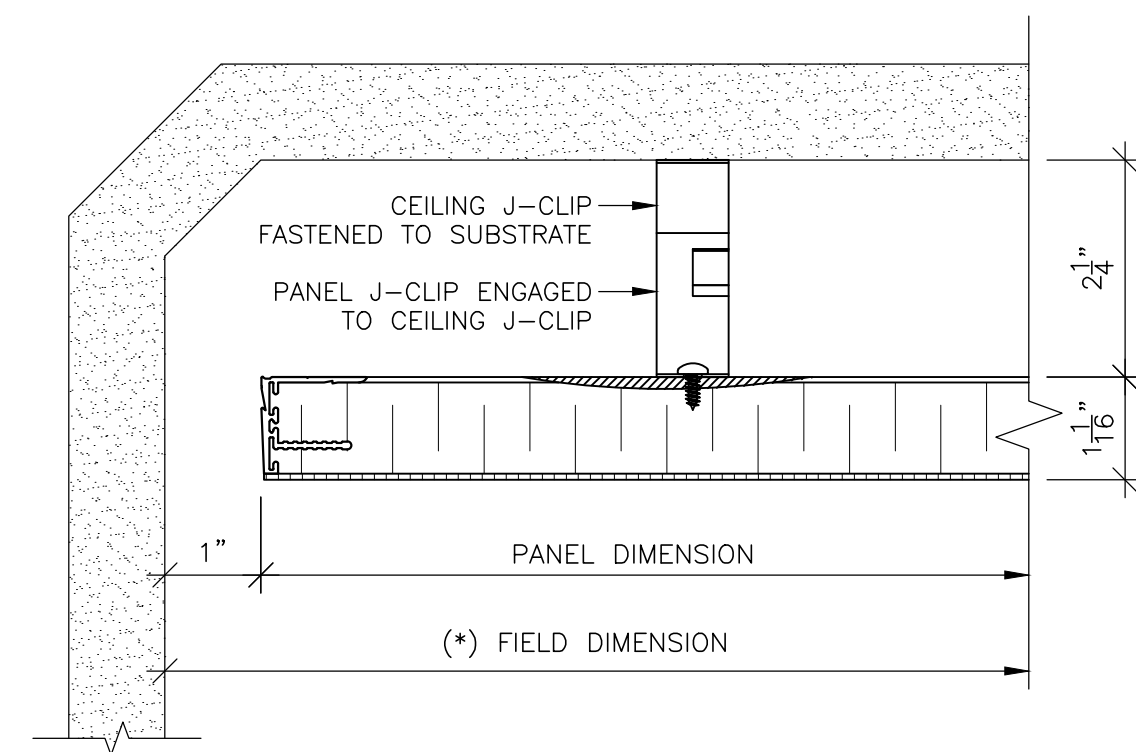

4 PERIMETER PANEL DETAIL
D1 SCALE: 6" = 1'-0"

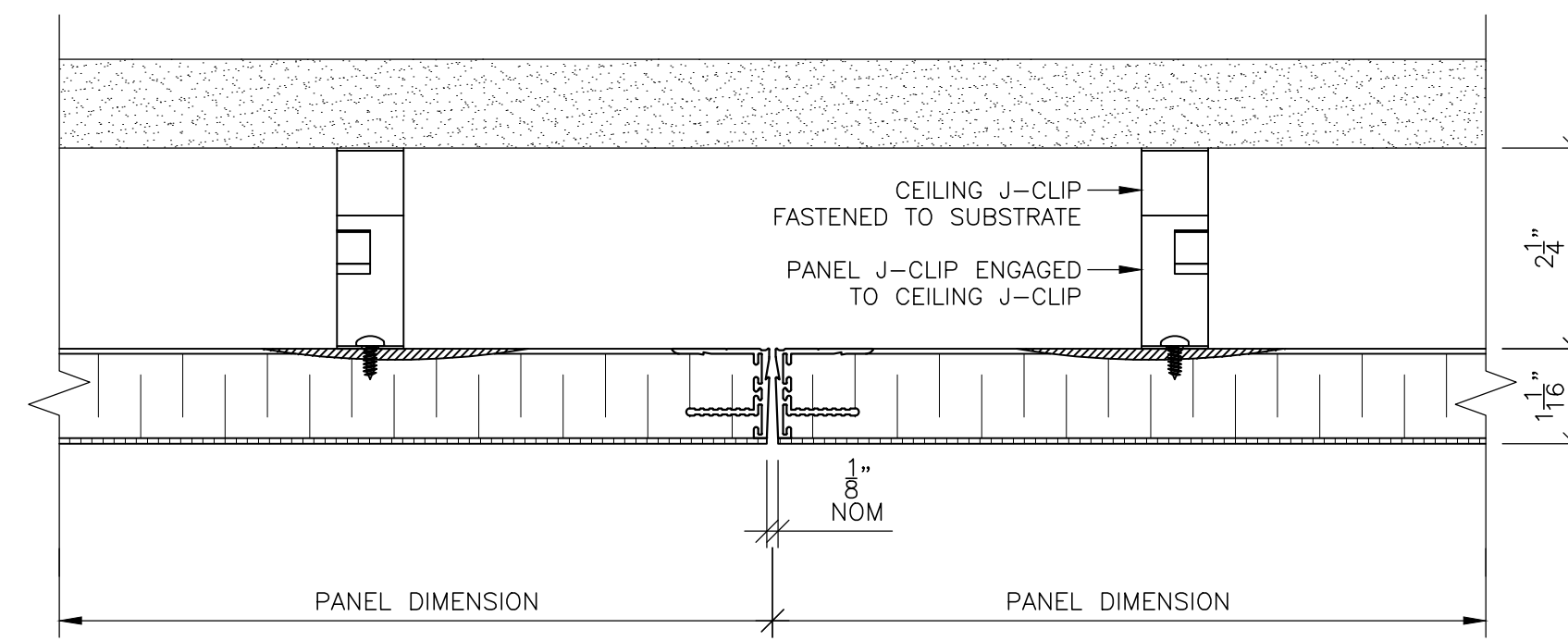

5 PANEL JOINT DETAIL
D1 SCALE: 6" = 1'-0"

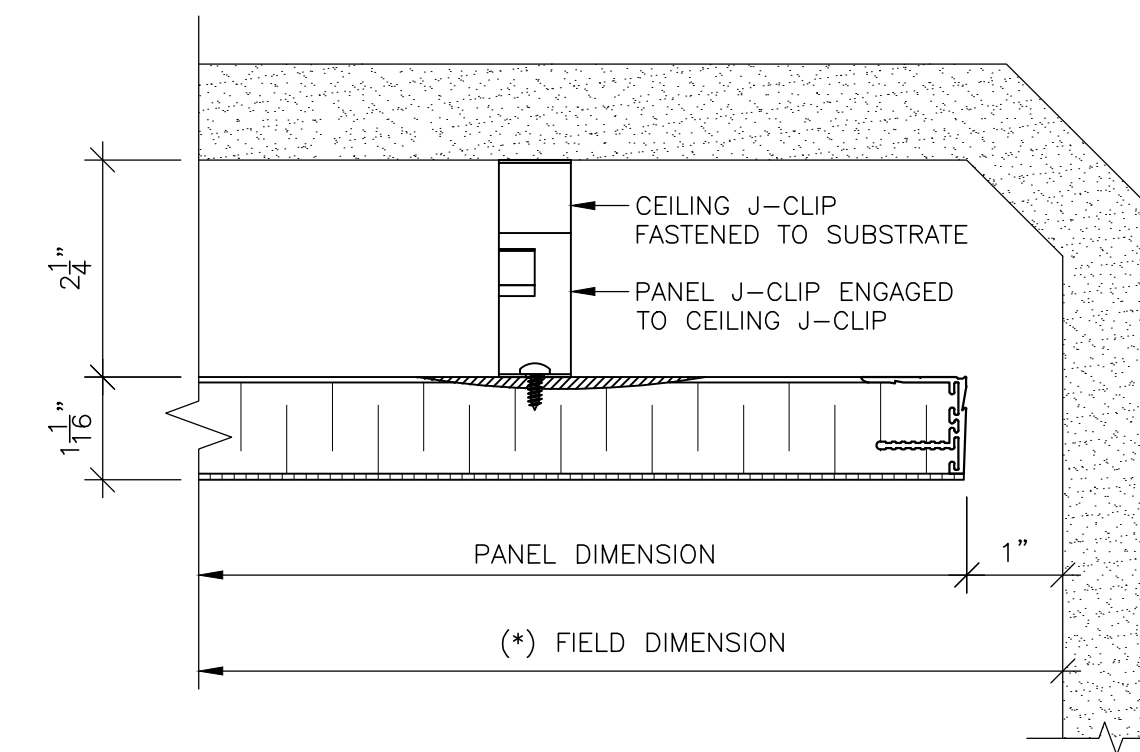

6 PERIMETER PANEL DETAIL
D1 SCALE: 6" = 1'-0"

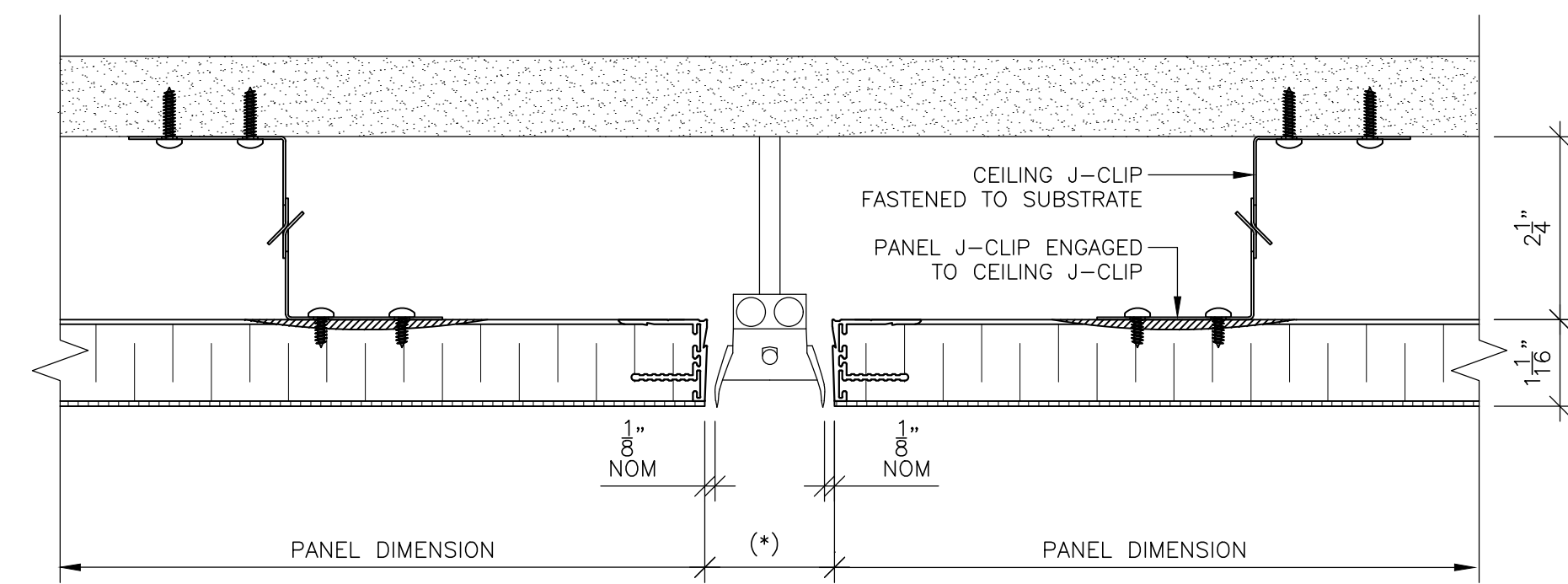

7 PANEL JOINT DETAIL
D1 SCALE: 6" = 1'-0"

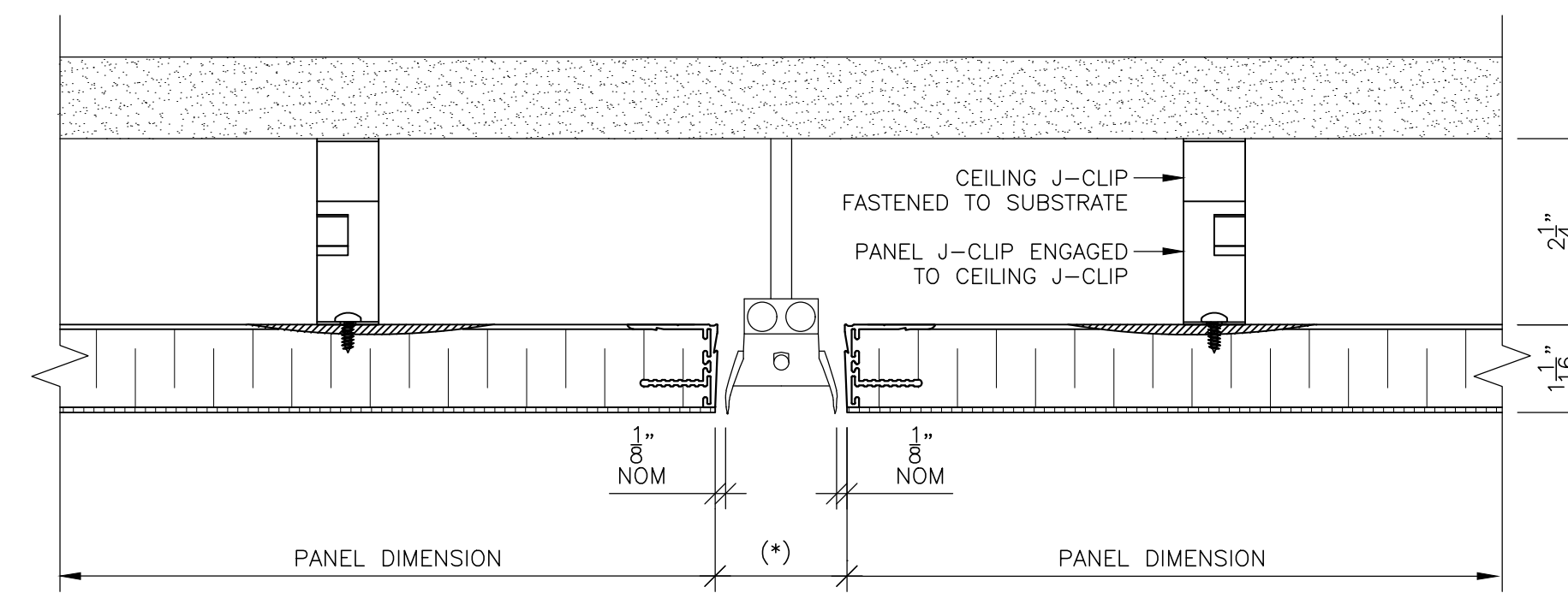

8 PANEL JOINT DETAIL
D1 SCALE: 6" = 1'-0"

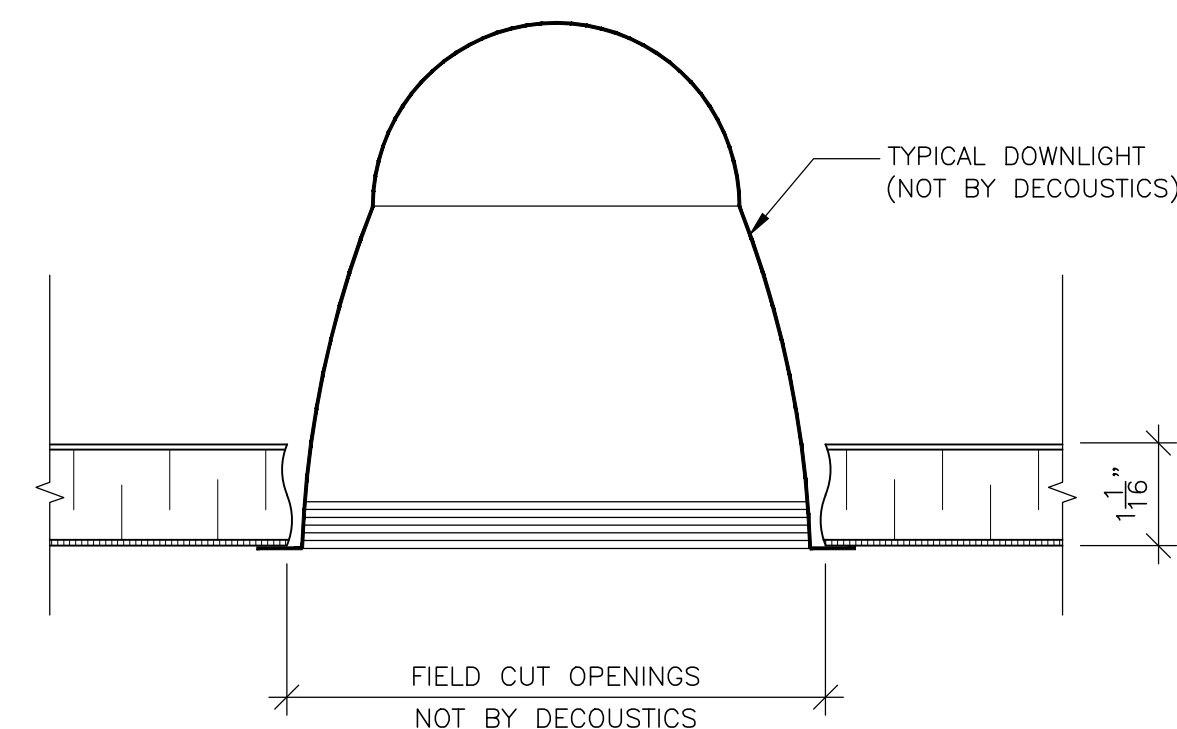

9 DETAIL @ DWN. LT.
D1 SCALE: 6" = 1'-0"

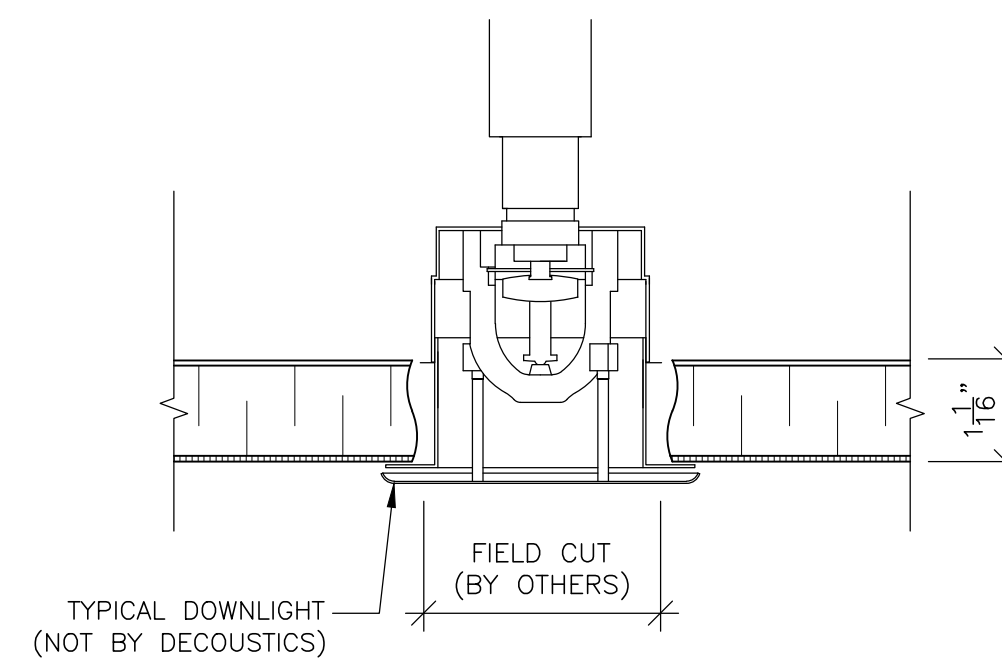



10 DETAIL @ SPRINKLER
D1 SCALE: 6" = 1'-0"

GENERAL NOTES:

- (*) PLEASE SUPPLY FIELD DIMENSIONS TO THE NEAREST 1/16". DECOUSTICS WILL CALCULATE PANEL SIZES.
- PLEASE VERIFY AND CONFIRM ALL DIMENSIONS, MOUNTING METHODS, AND DETAILS.
- ALL PANEL PENETRATIONS FOR LIGHT FIXTURES, ELECTRICAL OUTLETS, ETC. TO BE FIELD CUT BY OTHERS. (NOT BY DECOUSTICS)
- ALL GRILLES, DIFFUSERS, LIGHTS ETC. TO BE SUPPORTED INDEPENDENTLY OF ACOUSTIC PANELS.
- PANELS MUST BE INSTALLED FLAT & LEVEL TO +/- 1/16" OVER 8 FT. IT MAY BE NECESSARY TO SHIM HARDWARE AS REQUIRED.
- THE FINISHES USED ON DECOUSTICS PANELS ARE DIRECTIONAL. THE BACK OF EACH PANEL WILL BE MARKED TO SHOW THE CORRECT ORIENTATION FOR INSTALLATION.
- DO NOT BUTT PANELS NEXT TO EACH OTHER DURING INSTALLATION. ALLOW 1/16" BETWEEN PANELS TO ALLOW FOR PROPER ALIGNMENT.
- FOR ADDITIONAL PANEL INSTALLATION DETAILS, SEE DATA SHEETS.

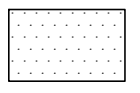
PANEL

 PANEL TYPE : ME-VCATT 1 1/16" THICK FLAT CEILING PANELS
 MOUNTING: DIRECT MOUNT
 EDGE DETAIL: CLARO FINISHED EXTRUDED ALUMINUM, SQUARE EDGES, 1/8" DEFINED PANEL JOINTS AND 1" REVEAL AROUND PERIMETER OF CEILING
 FINISH: CLARO
 COLOR: DECOUSTICS STANDARD WHITE

 PANEL TYPE : ME-VCATT 1 1/16" THICK FLAT CEILING PANELS
 MOUNTING: DIRECT SUSPENDED
 EDGE DETAIL: CLARO FINISHED EXTRUDED ALUMINUM, SQUARE EDGES, 1/8" DEFINED PANEL JOINTS AND 1" REVEAL AROUND PERIMETER OF CEILING
 FINISH: CLARO
 COLOR: DECOUSTICS STANDARD WHITE

CLEAN-AIR CLARO - COFFER

0	ORIGINAL ISSUE	28 APRIL 2020
REV.	PURPOSE	DATE

THIS DRAWING IS THE SOLE PROPERTY OF DECOUSTICS LIMITED AND CONTAINS CONFIDENTIAL INFORMATION AND IS TO BE USED ONLY UNDER EXPRESS AUTHORITY GIVEN, IN WRITING, BY DECOUSTICS LIMITED.

decoustics
 SAINT-GOBAIN
 61 Royal Group Crescent, Woodbridge, Ontario L4H 1X9 Canada
 Toll Free: 800-387-3809
 Main: 905-652-5200
 Fax: 905-652-2505

DRAWING	DRAWING TITLE	DRAWN BY	DWG. NO.
ARCHITECT	ARCHITECT	JL CHECKED BY SP	D1 PROJECT # ##### 1 OF X