

- GENERAL NOTES:**
- (1) PLEASE SUPPLY FIELD DIMENSIONS TO THE NEAREST 1/16". CERTAINTEED WILL CALCULATE PANEL SIZES.
 - PLEASE VERIFY AND CONFIRM ALL DIMENSIONS, MOUNTING METHODS, AND DETAILS.
 - ALL PANEL PENETRATIONS FOR LIGHT FIXTURES, ELECTRICAL OUTLETS, ETC. TO BE FIELD CUT BY OTHERS. (NOT BY CERTAINTEED)
 - ALL GRILLES, DIFFUSERS, LIGHTS ETC. TO BE SUPPORTED INDEPENDENTLY OF ACOUSTIC PANELS.
 - PANELS MUST BE INSTALLED FLAT & LEVEL TO +1/16" OVER 8 FT IT MAY BE NECESSARY TO SHIM HARDWARE AS REQUIRED.
 - THE FINISHES USED ON CERTAINTEED PANELS ARE DIRECTIONAL. THE BACK OF EACH PANEL WILL BE MARKED TO SHOW THE CORRECT ORIENTATION FOR INSTALLATION.
 - DO NOT BUTT PANELS NEXT TO EACH OTHER DURING INSTALLATION. ALLOW 1/16" BETWEEN PANELS TO ALLOW FOR PROPER ALIGNMENT.
 - FOR ADDITIONAL PANEL INSTALLATION DETAILS, SEE DATA SHEETS.

PANEL TYPE:

PANEL TYPE : 1 1/16" THICK FLAT CEILING PANELS
MOUNTING: COFFER
EDGE DETAIL: CLARO FINISHED EXTRUDED ALUMINUM, SQUARE EDGES, 1/8" DEFINED PANEL JOINTS AND 1" REVEAL AROUND PERIMETER OF CEILING
FINISH: PRODUCT-SPECIFIC
COLOR: TBD

3		
2		
1	COMBINE PRODUCTS	05-JULY-2021
0	INITIAL RELEASE	11-MAY-2021
REV.	PURPOSE	DATE

These drawings show typical conditions for installing the CertainTeed product shown. They should not be construed as a substitute for an architectural or engineering design and do not reflect the unique requirements of local codes, laws, statutes or regulations that may be applicable for a specific installation. CertainTeed assumes no liability for the accuracy or completeness of the drawings for a specific installation or the fitness of the drawings for a particular purpose. The user is advised to consult with local licensed design professionals in order to assure compliance with all legal requirements. CertainTeed is not licensed to provide professional engineering or architectural services.

**DECOUSTICS CLARO,
CLEAN-AIR CLARO,
EASY-CLEAN CLARO,
AND METALLO
ON COFFER**

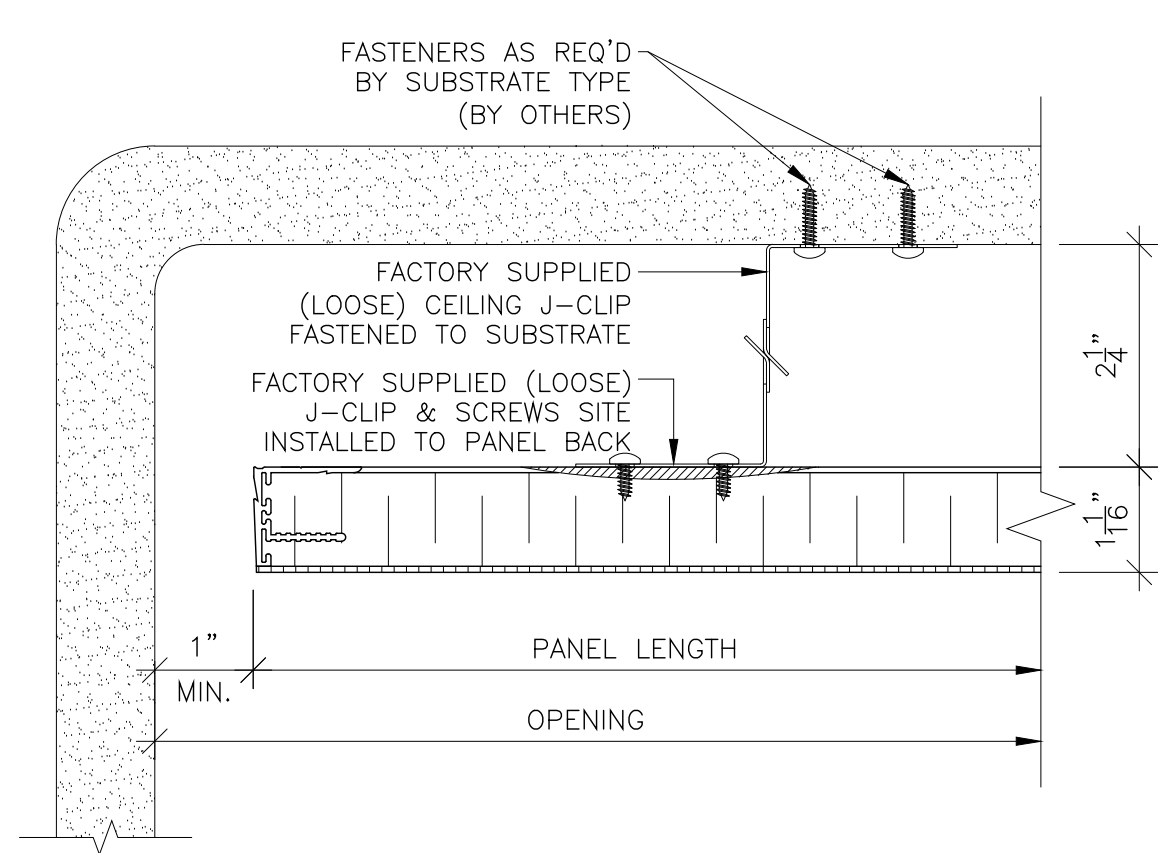

1 PERIMETER PANEL DETAIL
SCALE: 6" = 1'-0"

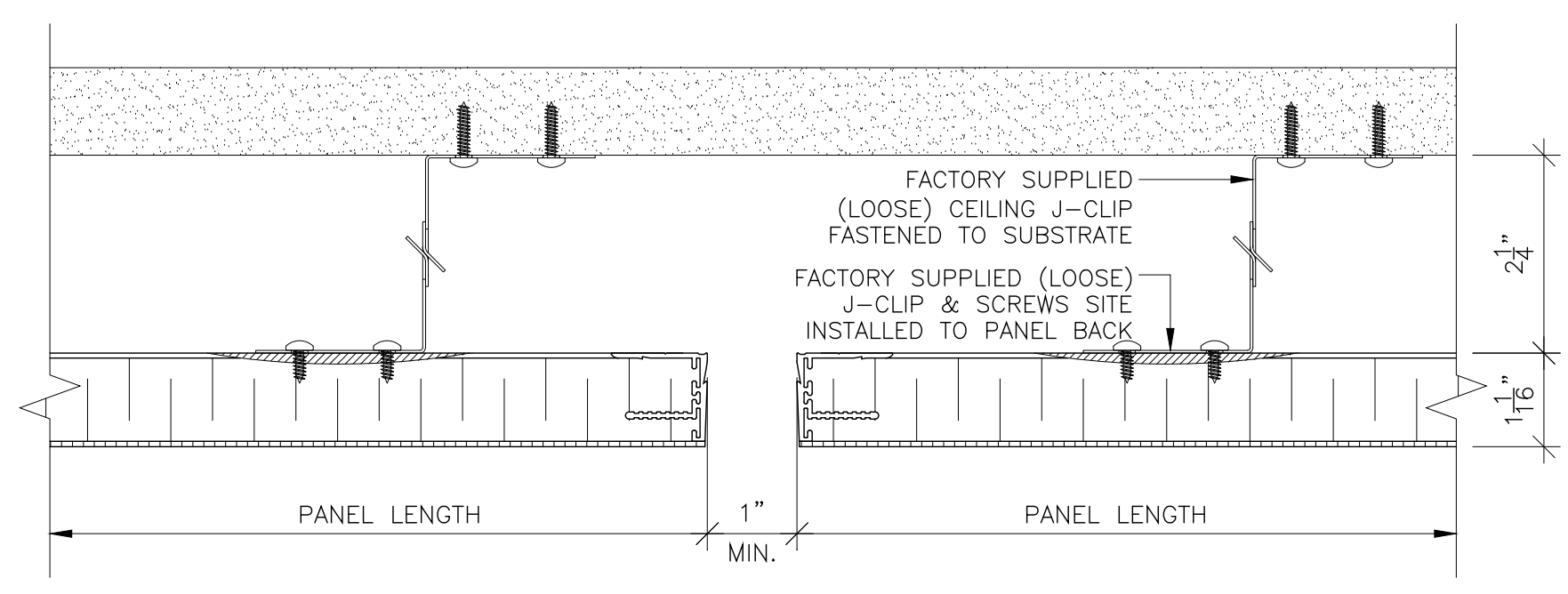

2 PANEL JOINT DETAIL
SCALE: 6" = 1'-0"

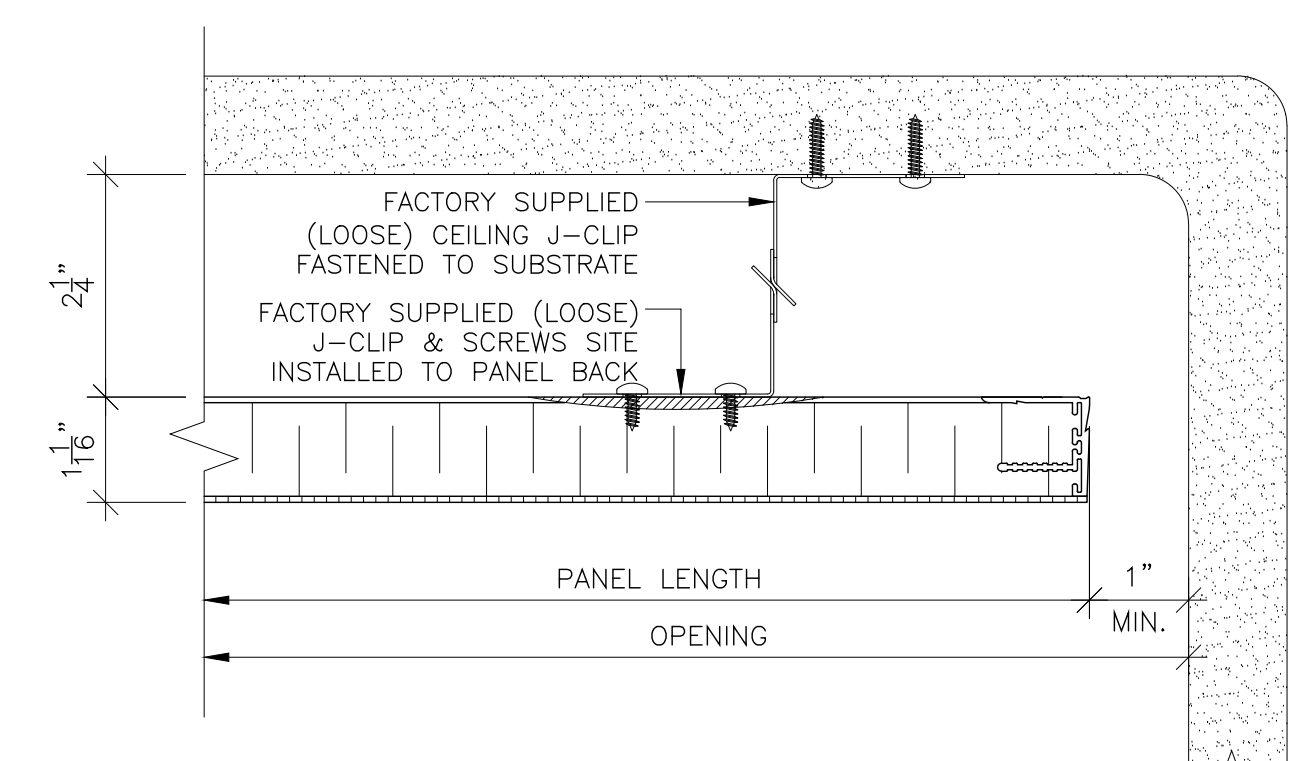

3 PERIMETER PANEL DETAIL
SCALE: 6" = 1'-0"

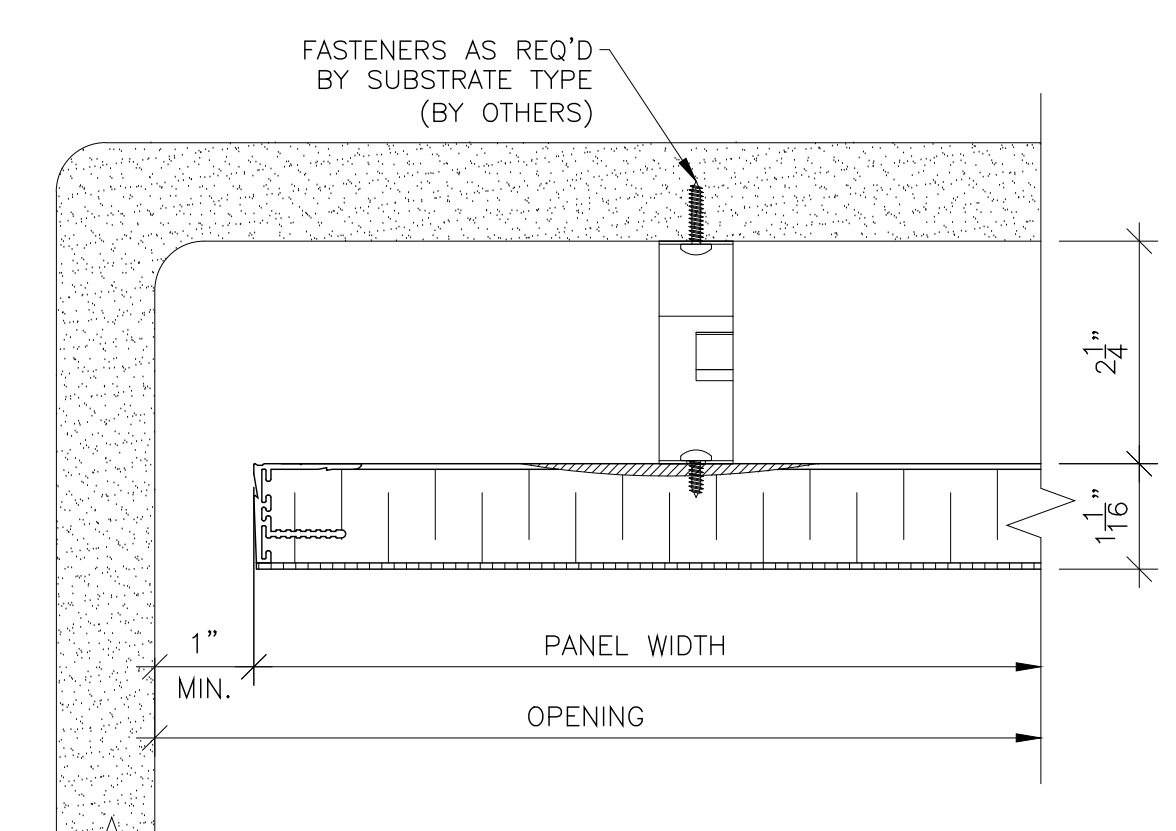

4 PERIMETER PANEL DETAIL
SCALE: 6" = 1'-0"

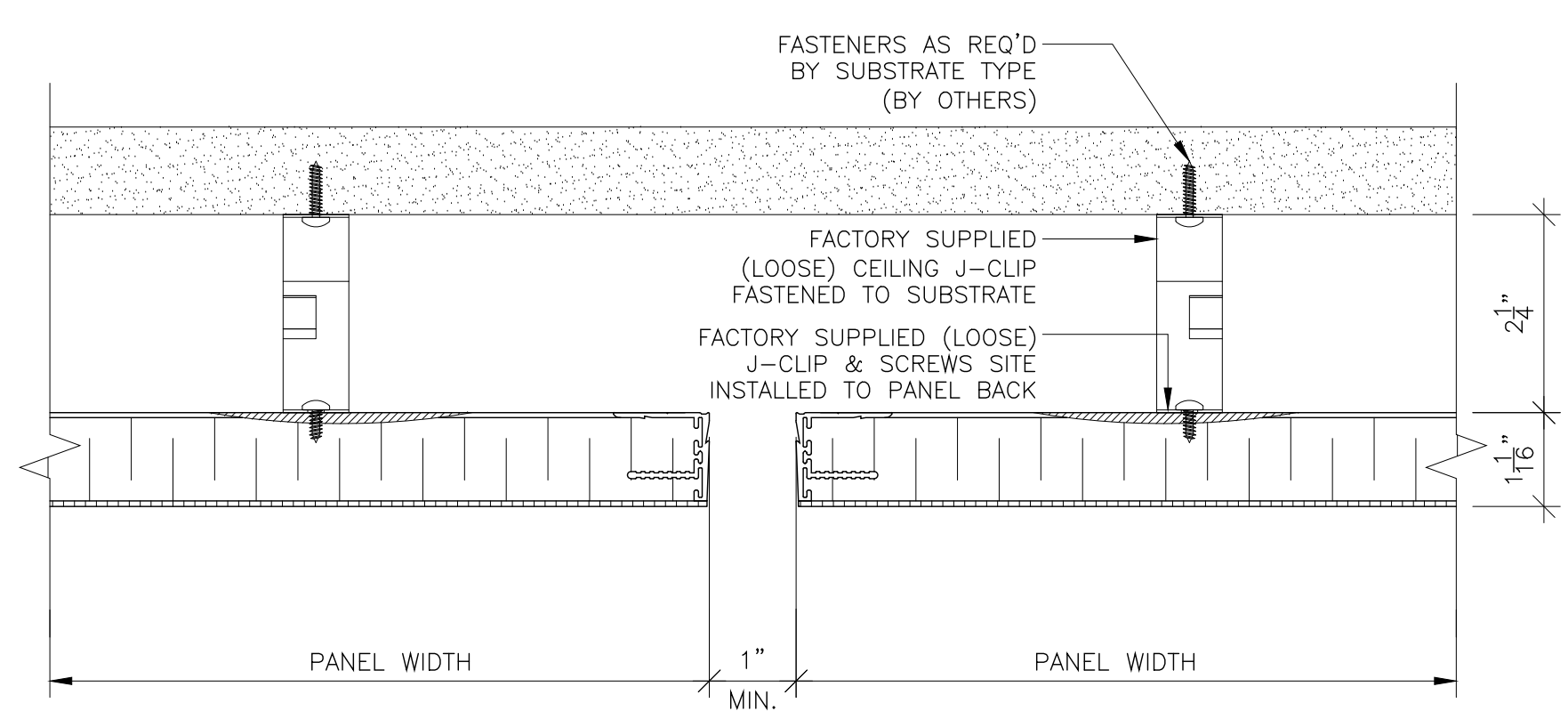

5 PANEL JOINT DETAIL
SCALE: 6" = 1'-0"

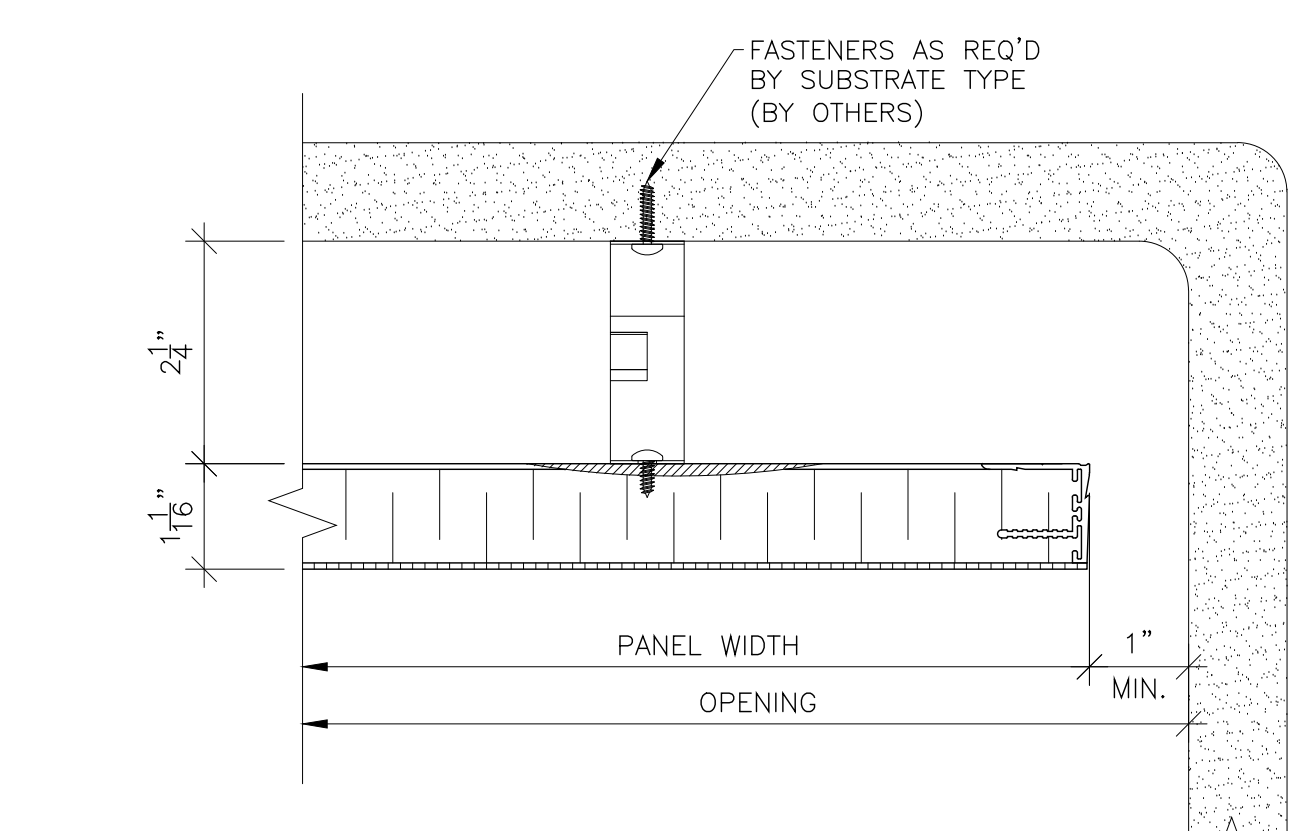

6 PERIMETER PANEL DETAIL
SCALE: 6" = 1'-0"

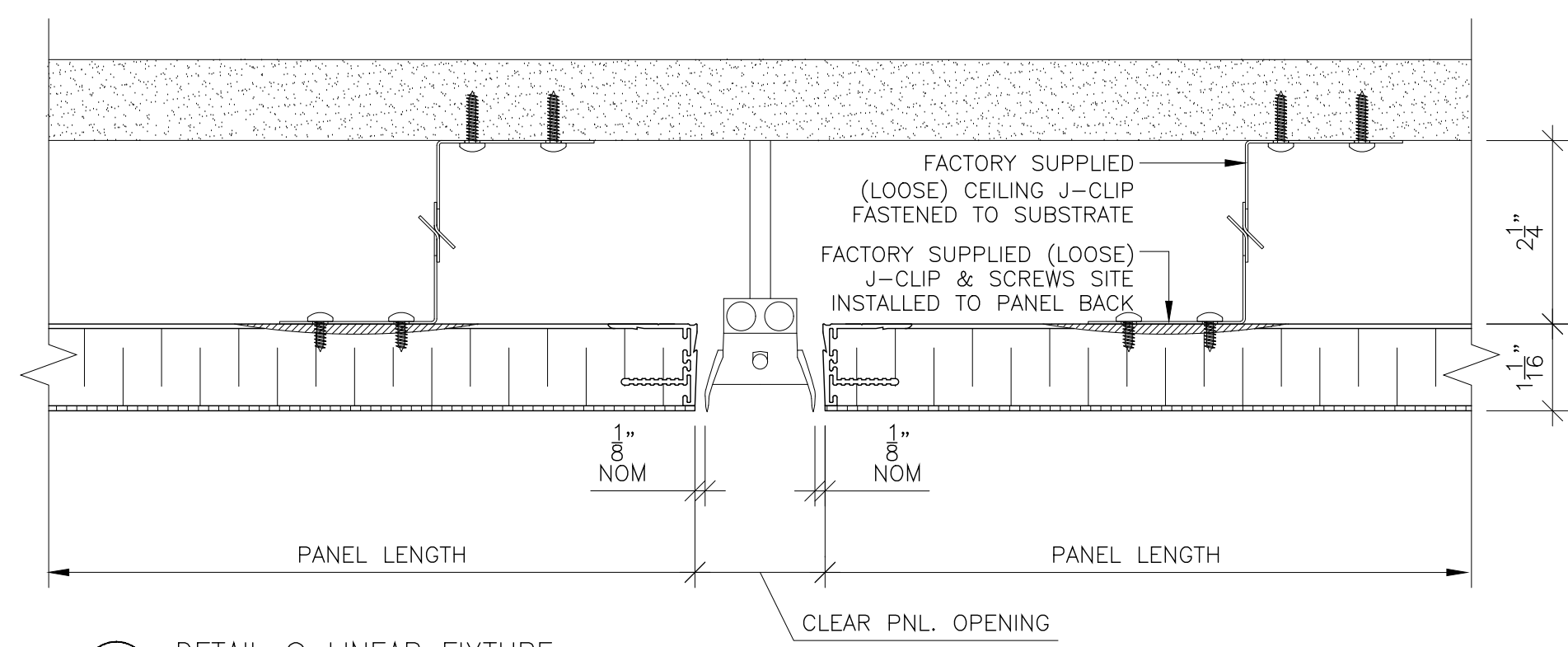

7 DETAIL @ LINEAR FIXTURE
SCALE: 6" = 1'-0"

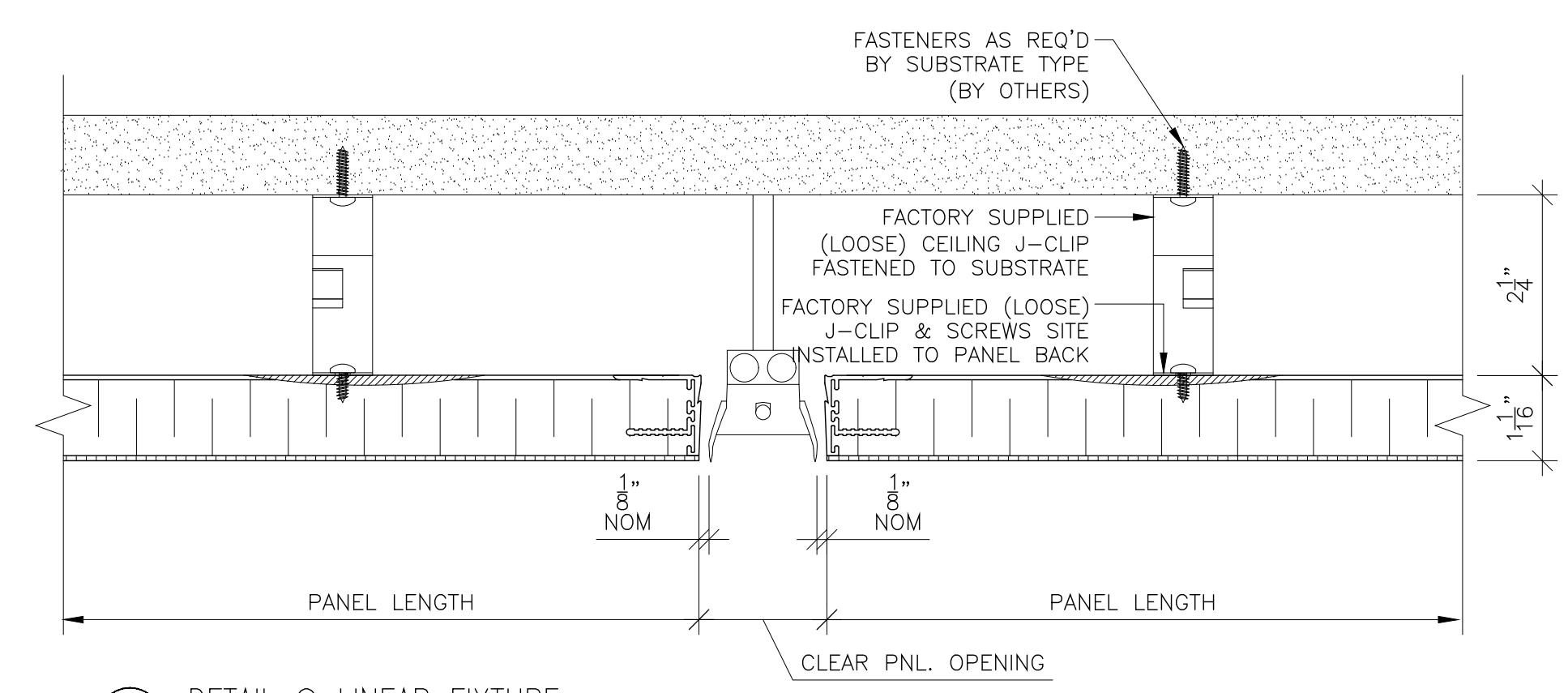

8 DETAIL @ LINEAR FIXTURE
SCALE: 6" = 1'-0"

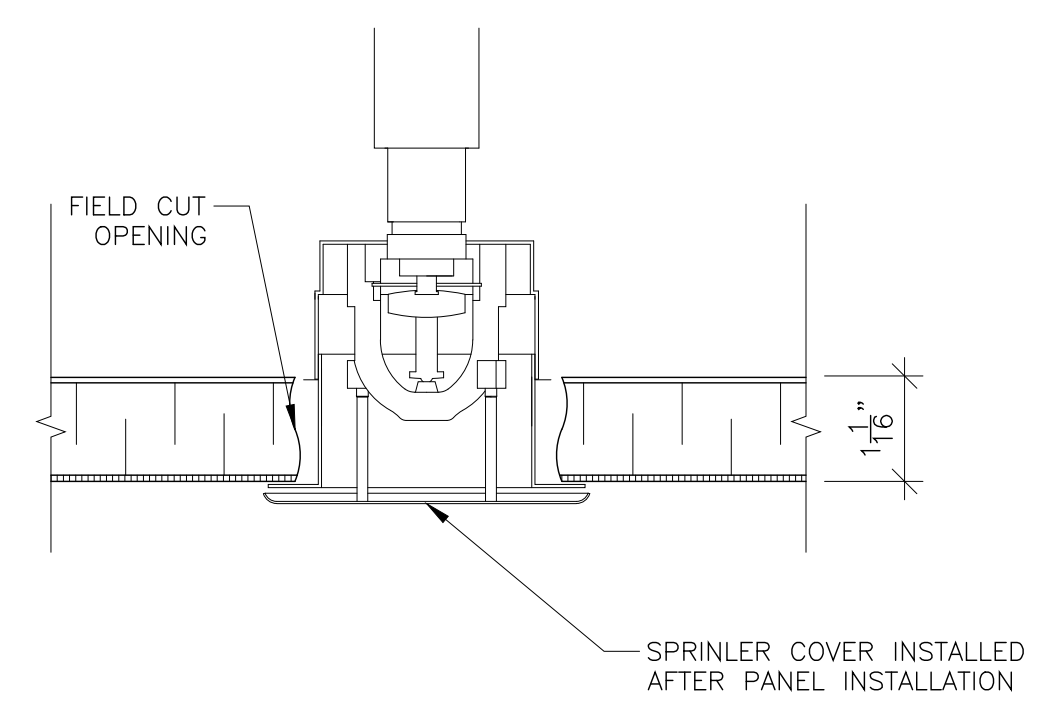

9 DETAIL @ SPRINKLER
SCALE: 6" = 1'-0"